



See the possibilities

User Manual

Tentative Version



GOX-5105M-5GE
GOX-8105M-5GE
GOX-12405M-5GE
GOX-16205M-5GE
GOX-20405M-5GE
GOX-24505M-5GE

GOX-5105C-5GE
GOX-8105C-5GE
GOX-12405C-5GE
GOX-16205C-5GE
GOX-20405C-5GE
GOX-24505C-5GE

*CMOS Digital Progressive Scan
Monochrome and Color Camera with GigE Interface*

*Document Version: Tentative
Go-X_Series_5GE_Manual_Ver.Tentative_2022-09-22*

Thank you for purchasing this product.

 Be sure to read this documentation before use.

This documentation includes important safety precautions and instructions on how to operate the unit. Be sure to read this documentation to ensure proper operation.

The contents of this documentation are subject to change without notice for the purpose of improvement.

Table of Contents

Table of Contents	2
About Technical Note	7
Notice/Warranty/Certifications	8
Notice	8
Warranty	8
Certifications	8
CE Compliance	8
FCC	8
Warning	9
Supplement	10
Supplement	11
Usage Precautions	12
Notes on Cable Configurations	12
Notes on Attaching The Lens	12
Notes on LAN Cable Connection	12
Phenomena Specific to CMOS Image Sensors	13
Notes on Exportation	13
Features	14
Feature Overview	14
Parts Identification	15
① Lens Mount (C-Mount)	15
② RJ-45 Connector	16
③ LINK LED	16
④ ACT LED	16
⑤ POWER/TRIG LED	17
⑥ DC IN/TRIG Connector (6-Pin Round)	17
⑦ ⑧ Camera Locking Screw Holes	18
Recommended Circuit Diagram (Reference Examples)	18
Recommended External Input Circuit Diagram	18
Recommended External Output Circuit Diagram	18

Characteristics of the Recommended Circuits for Opto OUT	19
Preparation	20
Step 1: Install the Software (First Time Only)	21
Step 2: Connect Devices	21
① Lens	22
② Direct Mounting (or Use MP-46 Tripod Adapter Plate)	23
③ LAN Cable	23
④ Network Card	24
⑤ DC IN / Trigger IN Connection Cable	24
⑥ AC Adapter (Power Supply) (If Necessary)	24
Step 3: Verify Camera Operation	24
Step 4: Verify the Connection between the Camera and PC	25
Step 5: Change the Camera Settings	27
Step 6: Adjust the Image Quality	28
Adjust the Gain	29
Adjust the White Balance	30
Adjust the Black Level	31
Step 7: Save the Settings	32
To Save User Settings	33
To Load User Settings	34
Main Functions	35
Acquisition Control	35
Changing the Frame Rate	36
Exposure Mode	37
Actual Exposure Time	38
RCT Mode	38
Trigger Control	39
When Using the FrameStart Trigger	40
Pixel Format	42
SensorDigitizationBits	43
Image Flip Function	43
GPIO (Digital Input/Output Settings)	44

VideoProcessBypassMode	45
Gain Control	46
Automatic Gain Level Control	46
White Balance	47
Color Temperature	47
ALC (Automatic Level Control) Function	48
To Use the ALC Function	48
Gamma Function	49
To Use the Gamma Function	49
LUT (Lookup Table)	50
To Use the LUT Function	50
LUT Value	50
BlemishCompensation	51
Automatic Detection	51
Manual Configuration	52
Shading Correction	53
To Use the Shading Correction Function	54
Binning Function	55
Image Scaling Mode (Xscale)	56
Specifying the Scaling Ratio	57
Decimation Mode	59
Gradation Compression Mode	60
Examples	61
Overlay Mode	63
ROI Function (Single ROI)	64
Single ROI - Example	65
ROI Function (Multi ROI)	66
Configuration Example	68
Color Space Conversion (ColorTransformationControl)	69
Edge Enhancer, Color Enhancer	70
Sequencer Function	71
TriggerSequencer Mode	71

Sample TriggerSequencer Mode Operation	72
CommandSequencer Mode	73
Pulse Generator	74
Counter and Timer Control Function	75
Counter Occurrence Diagram	75
Internal Camera Blocks	76
To Use the Counter Function	76
Action Control Function	77
Action Control Example	78
Event Control Function	79
Chunk Data Function	80
PTP (Precision Time Protocol)	80
Non-Volatile Flash Memory	81
Functions That Cannot Be Used Together	82
Setting List	83
Selector	83
Feature Properties	84
DeviceControl	84
TransportLayerControl	86
ImageFormatControl	90
MultiROIControl	96
AcquisitionControl	98
DigitalIOControl	100
PulseGenerator	103
AnalogControl	105
LUTControl	107
AutoLevelControl	108
ColorTransformationControl	110
ImagingControl	111
ShadingControl	112
BlemishControl	113
SequencerControl	114

CounterAndTimerControl	116
ActionControl	117
EventControl	118
ChunkDataControl	119
TestControl	120
UserSetControl	120
Miscellaneous	121
Troubleshooting	121
Power Supply and Connections	121
Image Display	121
Settings and Operations	121
Specifications	122
Package Contents	127
Spectral Response (GOX-5105M-5GE/GOX-5105C-5GE)	128
Spectral Response (GOX-8105M-5GE/GOX-8105C-5GE)	129
Spectral Response (GOX-12405M-5GE/GOX-12405C-5GE)	130
Spectral Response (GOX-16205M-5GE/GOX-16205C-5GE)	131
Spectral Response (GOX-20405M-5GE/GOX-20405C-5GE)	132
Spectral Response (GOX-24505M-5GE/GOX-24505C-5GE)	133
Dimensions	134
Comparison of the Decibel Display and Multiplier Display	135
User's Record	136
Revision History	137

About Technical Note



Some additional technical information is provided on the JAI website as Technical Notes. In this manual, if a technical note is available for a particular topic, the above icon is shown. Please refer to the following URL for Technical notes.

<https://www.jai.com/support-software/technical-notes>

Notice/Warranty/Certifications

Notice

The material contained in this manual consists of information that is proprietary to JAI Ltd., Japan, and may only be used by the purchasers of the product. JAI Ltd., Japan makes no warranty for the use of its product and assumes no responsibility for any errors which may appear or for damages resulting from the use of the information contained herein. JAI Ltd., Japan reserves the right to make changes without notice.

Company and product names mentioned in this manual are trademarks or registered trademarks of their respective owners.

Warranty

For information about the warranty, please contact your factory representative.

Certifications

CE Compliance

As defined by the Directive 2004/108/EC of the European Parliament and of the Council, EMC (Electromagnetic compatibility), JAI Ltd., Japan declares that GOX-5105M-5GE, GOX-5105C-5GE, GOX-8105M-5GE, GOX-8105C-5GE, GOX-12405M-5GE, GOX-12405C-5GE, GOX-16205M-5GE, GOX-16205C-5GE, GOX-20405M-5GE, GOX-20405C-5GE, GOX-24505M-5GE, and GOX-24505C-5GE comply with the following provisions applying to their standards.

EN 55032:2015(CISPR32:2015)

EN 55035:2017(CISPR35:2016)

FCC

This equipment has been tested and found to comply with the limits for a Class B digital device, pursuant to Part 15 of the FCC Rules. These limits are designed to provide reasonable protection against harmful interference in a residential installation. This equipment generates, uses, and can radiate radio frequency energy and, if not installed and used in accordance with the instructions, may cause harmful interference to radio communications. However, there is no guarantee that interference will not occur in a particular installation. If this equipment does cause harmful interference to radio or television reception, which can be determined by turning the equipment off and on, the user is encouraged to try to correct the interference by one or more of the following measures:

- Reorient or relocate the receiving antenna.
- Increase the separation between the equipment and receiver.

- Connect the equipment into an outlet on a circuit different from that to which the receiver is connected.
- Consult the dealer or an experienced radio/TV technician for help.

Warning

Changes or modifications to this unit not expressly approved by the party responsible for FCC compliance could void the user's authority to operate the equipment.

Supplement

The following statement is related to the regulation on “Measures for the Administration of the Control of Pollution by Electronic Information Products”, known as “China RoHS”. The table shows contained Hazardous Substances in this camera.

 mark shows that the environment-friendly use period of contained Hazardous Substances is 15 years.

Applicable models: GOX-5105M-5GE, GOX-8105M-5GE, GOX-12405M-5GE, GOX-16205M-5GE, GOX-20405M-5GE, GOX-24505M-5GE

重要注意事项

有毒，有害物质或元素名称及含量表

根据中华人民共和国信息产业部『电子信息产品污染控制管理办法』，本产品《有毒，有害物质或元素名称及含量表》如下。

部件名称	有毒有害物质或元素					
	铅 (Pb)	汞 (Hg)	镉 (Cd)	六价铬 (Cr (VI))	多溴联苯 (PBB)	多溴二苯醚 (PBDE)
电路板	×	○	○	○	○	○
螺丝	×	○	○	○	○	○
插座	×	○	○	○	○	○
.....

○:表示该有毒有害物质在该部件所有均质材料中的含量均在GB/T 26572-2011规定的限量要求以下。
 ×:表示该有毒有害物质至少在该部件的某一均质材料中的含量超出GB/T 26572-2011规定的限量要求。

环保使用期限



电子信息产品中含有的有毒有害物质或元素在正常使用的条件下不会发生外泄或突变、电子信息产品用户使用该电子信息产品不会对环境造成严重污染或对其人身、财产造成严重损害的期限。

数字「15」为期限15年。

Supplement

The following statement is related to the regulation on “Measures for the Administration of the Control of Pollution by Electronic Information Products”, known as “China RoHS”. The table shows contained Hazardous Substances in this camera.

 mark shows that the environment-friendly use period of contained Hazardous Substances is 15 years.

Applicable models: GOX-5105C-5GE, GOX-8105C-5GE, GOX-12405C-5GE, GOX-16205C-5GE, GOX-20405C-5GE, GOX-24505C-5GE

重要注意事项

有毒，有害物质或元素名称及含量表

根据中华人民共和国信息产业部『电子信息产品污染控制管理办法』，本产品《有毒，有害物质或元素名称及含量表》如下。

部件名称	有毒有害物质或元素					
	铅 (Pb)	汞 (Hg)	镉 (Cd)	六价铬 (Cr (VI))	多溴联苯 (PBB)	多溴二苯醚 (PBDE)
电路板	×	○	○	○	○	○
螺丝	×	○	○	○	○	○
插座	×	○	○	○	○	○
光学滤镜	×	○	×	○	○	○
.....

○:表示该有毒有害物质在该部件所有均质材料中的含量均在GB/T 26572-2011规定的限量要求以下。

×:表示该有毒有害物质至少在该部件的某一均质材料中的含量超出GB/T 26572-2011规定的限量要求。

环保使用期限



电子信息产品中含有的有毒有害物质或元素在正常使用的条件下不会发生外泄或突变、电子信息产品用户使用该电子信息产品不会对环境造成严重污染或对其人身、财产造成严重损害的期限。

数字「15」为期限15年。

Usage Precautions

Notes on Cable Configurations

The presence of lighting equipment and television receivers nearby may result in video noise. In such cases, change the cable configurations or placement.

Notes on Attaching The Lens



Technical Notes

How to Clean a Sensor

Avoiding Dust Particles

When attaching the lens to the camera, stray dust and other particles may adhere to the sensor surface and rear surface of the lens. Be careful of the following when attaching the lens.

- Work in a clean environment.
- Do not remove the caps from the camera and lens until immediately before you attach the lens.
- To prevent dust from adhering to surfaces, point the camera and lens downward and do not allow the lens surface to come into contact with your hands or other objects.
- Always use a blower brush to remove any dust that adheres.
- Never use your hands or cloth, blow with your mouth, or use other methods to remove dust.

Notes on LAN Cable Connection

Secure the locking screws on the connector manually, and do not use a driver. Do not secure the screws too tightly. Doing so may wear down the screw threads on the camera. (Tightening torque: 0.147 Nm or less)

Caution: Secure manually. Do not secure too tightly.

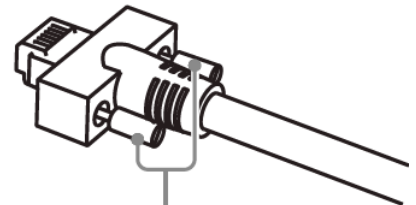

Phenomena Specific to CMOS Image Sensors

The following phenomena are known to occur on cameras equipped with CMOS image sensors. These do not indicate malfunctions.

- **Aliasing:** When shooting straight lines, stripes, and similar patterns, vertical aliasing (zigzag distortion) may appear on the monitor.
- **Blooming:** When strong light enters the camera, some pixels on the CMOS image sensor may receive much more light than they are designed to hold, causing the accumulated signal charge to overflow into surrounding pixels. This “blooming” phenomenon can be seen in the image but does not affect the operation of the camera.
- **Fixed pattern noise:** When shooting dark objects in high-temperature conditions, fixed pattern noise may occur throughout the entire video monitor screen.
- **Defective pixels:** Defective pixels (white and black pixels) of the CMOS image sensor are minimized at the factory according to shipping standards. However, as this phenomenon can be affected by the ambient temperature, camera settings (e.g., high sensitivity and long exposure), and other factors, be sure to operate within the camera’s specified operating environment.

Notes on Exportation

When exporting this product, please follow the export regulations of your country or region.

Features

These camera models are industrial progressive scan cameras equipped with a global shutter CMOS image sensor. These small-size cameras (approx. 29mm x 29mm x 68mm) are also lightweight (TBD g), which makes them easy to install and mount. In addition, these provide an attractive combination of high resolution, high speed, and high image quality for machine vision applications.

Model Name	Image Sensor		Active Pixels	Pixel Size	Max Frame Rate*
GOX-5105M-5GE	Mono	Type 1/1.8	2472 x 2064	2.74 μm x 2.74 μm	103 fps
GOX-5105C-5GE	Color				
GOX-8105M-5GE	Mono	Type 2/3	2856 x 2848	2.74 μm x 2.74 μm	66 fps
GOX-8105C-5GE	Color				
GOX-12405M-5GE	Mono	Type 1/1.1	4128 x 3008	2.74 μm x 2.74 μm	43 fps
GOX-12405C-5GE	Color				
GOX-16205M-5GE	Mono	Type 1.1	5328 x 3040	2.74 μm x 2.74 μm	33 fps
GOX-16205C-5GE	Color				
GOX-20405M-5GE	Mono	Type 1.1	4512 x 4512	2.74 μm x 2.74 μm	27 fps
GOX-20405C-5GE	Color				
GOX-24505M-5GE	Mono	Type 1.2	5328 x 4608	2.74 μm x 2.74 μm	22 fps
GOX-24505C-5GE	Color				

*When Pixel Format = **Mono8/BayerRG8**, SensorDigitizationBits = **10 Bits**, NetworkThroughputSafetyMargin = **92**, Packet Size = **12036**, ExtendedIDMode = **Off**.

Feature Overview

- Global shutter CMOS image sensor with backside illuminated pixel technology
- 8/10/12-bit output in choice of monochrome or raw Bayer color models
- Flexible ROI; rescaling function (monochrome and color); traditional 1x2, 2x1, 2x2 binning (monochrome models); horizontal/vertical image flip function; blemish correction; shading compensation; sequencer function; and Automatic Level Control (ALC). (See the [Main Functions](#) chapter for details).
- Compact size with excellent shock and vibration resistance
- PoE or via separate 6-pin connector
- Lens mount: C-mount

Parts Identification

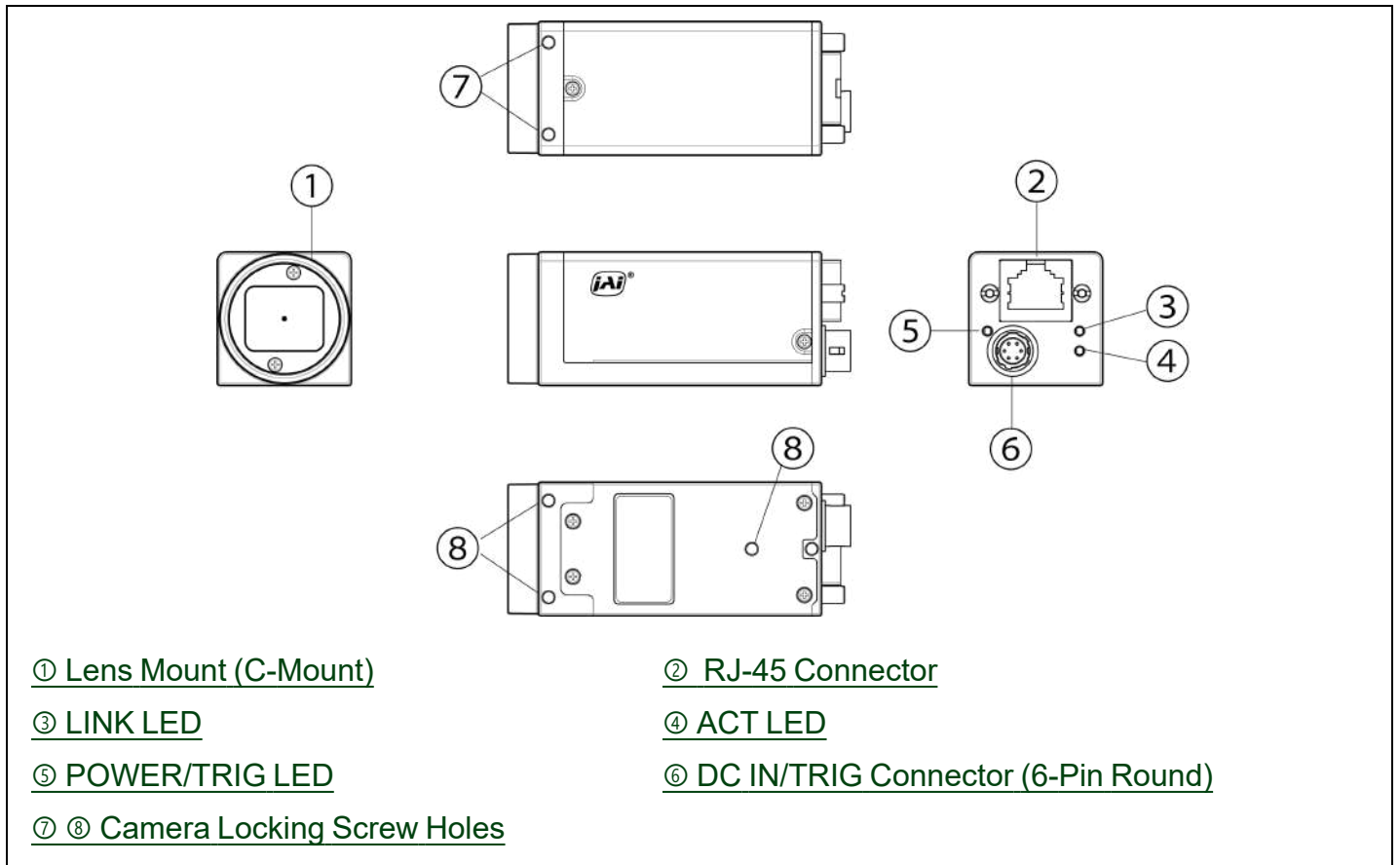

① Lens Mount (C-Mount)

Mount a C-mount lens, microscope adapter, etc. here.

Note: Before mounting a lens, be sure to refer to [① Lens](#) and confirm the precautions for attaching a lens and the supported lens types.



② RJ-45 Connector

Connect a Gigabit Ethernet compatible LAN cable (Category 5e or higher, Category 6 recommended) here.

 RJ45 with Locking Screws	GigE Vision Interface	
	Pin	Signal
1	TRD+ (0)	
2	TRD- (0)	
3	TRD+ (1)	
4	TRD+ (2)	
5	TRD- (2)	
6	TRD- (1)	
7	TRD+ (3)	
8	TRD- (3)	



③ LINK LED

Indicates whether the GigE network connection is established or not.

LED		Status
	Off	The network link is not established (or in progress).
	Blinking green (slow)	1000BASE-T link is established. (Interval 1sec)
	Blinking green (quick)	2.5GBASE-T or 5GBASE-T link is established. (Interval 200ms)



④ ACT LED

Indicates the GigE network status.

LED		Status
	Off	Communication is not active.
	Blinking amber	Communication is active.

⑤ POWER/TRIG LED

Indicates the power or trigger input status.

LED		Status
	Lit amber	Camera initializing
	Lit green	Camera in operation
	Blinking green	During operation in trigger mode, trigger signals are being input. Note: The blinking interval is not related to the actual input interval of the external trigger.

⑥ DC IN/TRIG Connector (6-Pin Round)

Connect the cable for a power supply (optional) or for DC IN / trigger IN here.

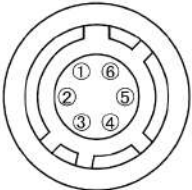
	Camera Side: HR10A-7R-6PB (Hirose Electric or equivalent)		
	Cable Side: : HR10A-7P-6S (Plug) (Hirose Electric or equivalent)		
Pin No.	Input/Output	Signal	Description
1	Power In	DC In	DC in +10V ~ +25V
2	In	Opto In+	Line 5
3	In	Opto In-	
4	Out	Opto Out+	Line 2
5	Out	Opto Out-	
6	GND	GND	

Notes:

- See [Recommended Circuit Diagram \(Reference Examples\)](#) for the recommended Input/Output circuit diagrams.
- Refer to the [GPIO \(Digital Input/Output Settings\)](#) topic as well.

⑦ ⑧ Camera Locking Screw Holes

Use these holes when mounting the camera directly to a wall or other structural system.

- ⑦ Upper part of camera: M3, 3mm depth, 20mm pitch
- ⑧ Lower part of camera: M3, 4mm depth, 21mm pitch (lens side)

Recommended Circuit Diagram (Reference Examples)

Related Setting Items: [DigitalIOControl](#)

Technical Notes OPTO-In Circuit Characteristics

Note: The OptInFilter function ([DeviceControl](#)) can eliminate the chattering that occurs when switching between the Low and High OptoIn signals up to 40ms.

Recommended External Input Circuit Diagram

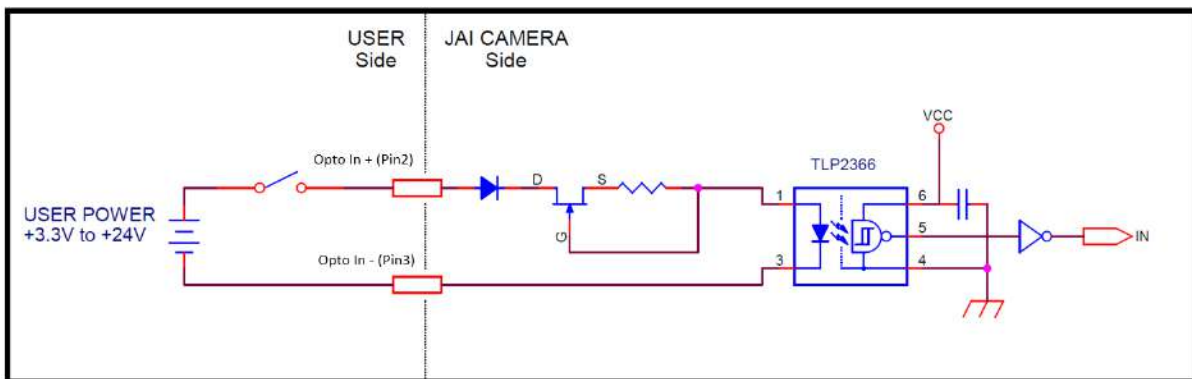

Recommended External Output Circuit Diagram

Reference Example

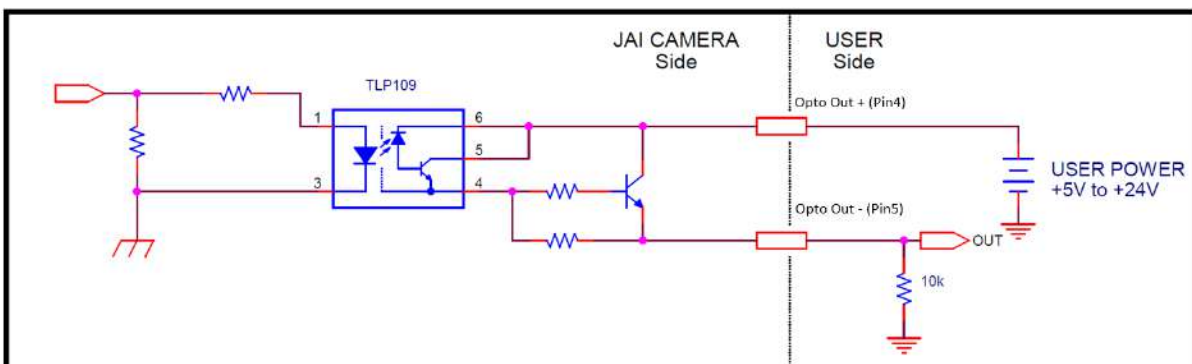

Characteristics of the Recommended Circuits for Opto OUT

OUTPUT LINE RESPONSE TIME

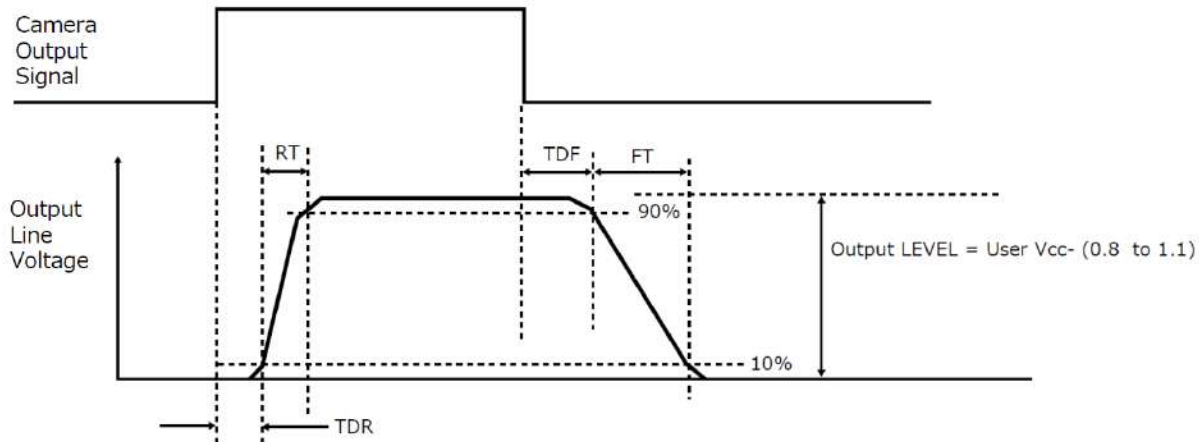

For the operating conditions of applied voltage (User Power) +12V, load resistance 10kΩ, and cable length 1m, the timing is shown in the table below.

Item	Result (Typ)
TDR (Time Delay Rise)	0.48 (μs)
RT (Rise Time)	3.08 (μs)
TDF (Time Delay Fall)	3.16 (μs)
FT (Fall Time)	52.4 (μs)

Note: Since it varies depending on the applied voltage, load resistance, cable length, etc., check the actual environment before use.

Cautions:

Please note that the recommended load resistance of Opto output is 10 kΩ (rated 1/10 W) or more. The 270 Ω resistor shown in the circuit diagram is the MINIMUM resistance that should be used. The response speed from On (High) to Off (Low) depends on the voltage applied to Opto output and the value of the load resistance. Higher load resistance results in a slower response. If the response at 10 kΩ is slower than desired, you can try reducing the load resistance in order to increase the response speed but DO NOT go below the minimum 270 Ω value.

The load resistance loss can be calculated as follows.

$$\text{load resistance loss} \cong (\text{voltage applied to Opto output})^2 / (\text{load resistance})$$

Preparation

Read this section to learn how the camera connects to devices and accessories. The preparation process is described below.

Step 1: Install the Software (First Time Only)

- Install the software for configuring and controlling the camera (eBUS SDK for JAI) on the computer.

Step 2: Connect Devices

- Connects the lens, LAN cable, computer, and other devices.

Step 3: Verify Camera Operation

- Verify whether the camera is turned on and ready for use.

Step 4: Verify the Connection between the Camera and PC

- Verify whether the camera is properly recognized via Control Tool.

Step 5: Change the Camera Settings

- Refer to the procedure for changing the output format setting as an example, and change various settings as necessary.

Step 6: Adjust the Image Quality

- Refer to the procedures for adjusting the gain, white balance, and black level as examples, and adjust the image quality.

Step 7: Save the Settings

- Save the current setting configurations in user memory.

Step 1: Install the Software (First Time Only)

When using the camera for the first time, install the software for configuring and controlling the camera (eBUS SDK for JAI) on the computer.

Note: When you install eBUS SDK for JAI, eBUS Player for JAI will also be installed.

1. Download the eBUS SDK for JAI from the JAI website (<https://www.jai.com/support-software/jai-software>).
2. Install eBUS SDK for JAI on the computer.

Step 2: Connect Devices

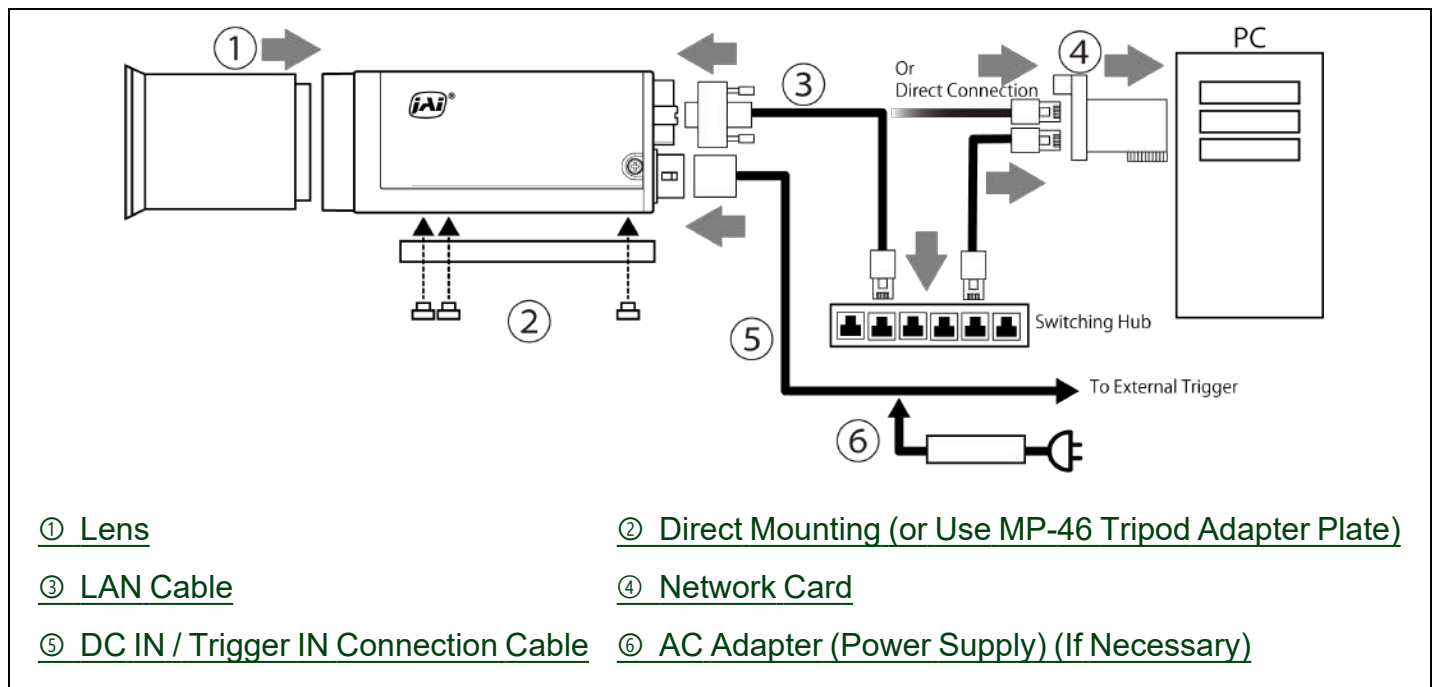

① Lens

Technical Notes Lens Selection Guide

C-mount lenses with lens mount protrusions of 9 mm or less can be attached.

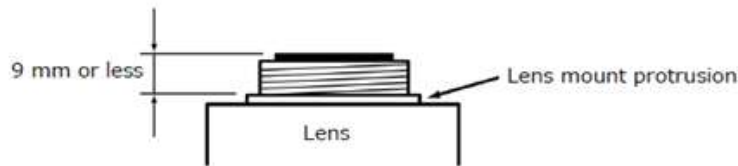

To prevent vignetting and to obtain the optimal resolution, use a lens that will cover the image sensor size.

Model Name	Image Sensor		
GOX-5105M-5GE	Mono	Type 1/1.8	6.8 mm x 5.7 mm (8.82mm diagonal)
GOX-5105C-5GE	Color		
GOX-8105M-5GE	Mono	Type 2/3	7.8 mm x 7.8 mm (11.05mm diagonal)
GOX-8105C-5GE	Color		
GOX-12405M-5GE	Mono	Type 1/1.1	11.3 mm x 8.2 mm (14.00mm diagonal)
GOX-12405C-5GE	Color		
GOX-16205M-5GE	Mono	Type 1.1	14.6 mm x 8.3 mm (16.81mm diagonal)
GOX-16205C-5GE	Color		
GOX-20405M-5GE	Mono	Type 1.1	12.4 mm x 12.4 mm (17.48mm diagonal)
GOX-20405C-5GE	Color		
GOX-24505M-5GE	Mono	Type 1.2	14.6 mm x 12.6 mm (19.30mm diagonal)
GOX-24505C-5GE	Color		

Notes:

The following formula can be used to estimate the focal length.

$$\text{Focal length} = \text{WD} / (1 + \text{W/w})$$

WD: Working distance (distance between lens and object)

W: Width of object

w: Width of sensor

Cautions:

- The maximum performance of the camera may not be realized depending on the lens.
- Attaching a lens with a mount protrusion of 9 mm or longer may damage the lens or camera.

② Direct Mounting (or Use MP-46 Tripod Adapter Plate)

When mounting the camera directly to a wall or other device, use screws that match the camera locking screw holes on the camera (M3: depth 4mm for the lower part, depth 3 mm for the upper part).

Use the supplied screws to attach the tripod adapter plate (lower mounting holes).

Caution: For heavy lenses, be sure to support the lens itself. Do not use configurations in which its weight is supported by the camera.

③ LAN Cable

Connect a LAN cable to the RJ-45 connector. The camera supports the following Ethernet standards: 1000BASE-T, 2.5GBASE-T, 5GBASE-T.

- Use a LAN cable that is Category 5e or higher (Category 6 recommended).
- Use a LAN cable that is an STP cable.
- When supplying power via PoE, connect to a PoE-compatible switching hub or a PoE-compatible network card.
- Refer to the specifications of the cable for details on its bend radius.

The longest cable length varies depending on the type of LAN cable and the Ethernet standard. Below, the table shows the relationship diagram between LAN cable type and Ethernet standard. Correctly select the LAN cable type according to the Ethernet standard to be used.

	Cat5e	Cat6/Cat6e	Cat6A	Cat7
1000BASE-T	100m	100m	100m	100m
2.5GBASE-T	100m	100m	100m	100m
5GBASE-T	-	100m	100m	100m

Caution: See the [Notes on LAN Cable Connection](#) topic as well.

④ Network Card

Install this in the computer that will be used to configure and operate the camera. As the camera supports PoE, you can also use PoE-compatible network cards. Refer to the instruction manual of the network card, and configure settings on the computer as necessary.

⑤ DC IN / Trigger IN Connection Cable

Performs external I/O such as power supply and trigger input.

⑥ AC Adapter (Power Supply) (If Necessary)

Connect the AC adapter and the round connector of the connection cable to the DC IN / Trigger IN connector on the camera.

Step 3: Verify Camera Operation

When power is supplied to the camera while the necessary equipment is connected, the POWER/TRIG LED at the rear of the camera lights amber, and initialization of the camera starts. When initialization is complete, the POWER/TRIG LED lights green.

Verify whether power is being supplied to the camera by checking the rear LED. When properly turned on, the power LED is lit green.

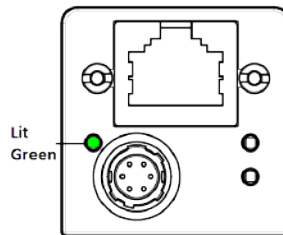

For details on how to read the LEDs, see the [⑤ POWER/TRIG LED](#) section.

Step 4: Verify the Connection between the Camera and PC

Verify whether the camera is properly recognized via Control Tool.



1. Launch eBUS Player for JAI. 
2. Select the camera you want to configure. Click the **Select / Connect** button.

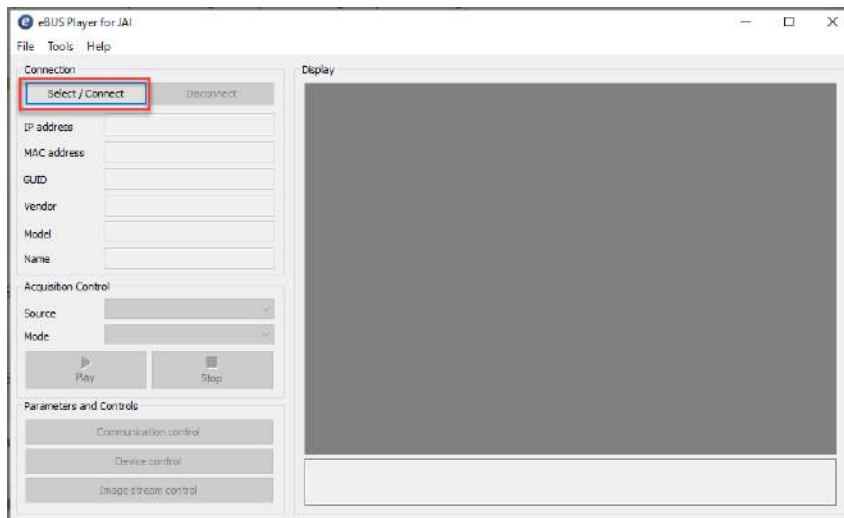

3. The connected camera is listed. Please select one camera and click **OK**.

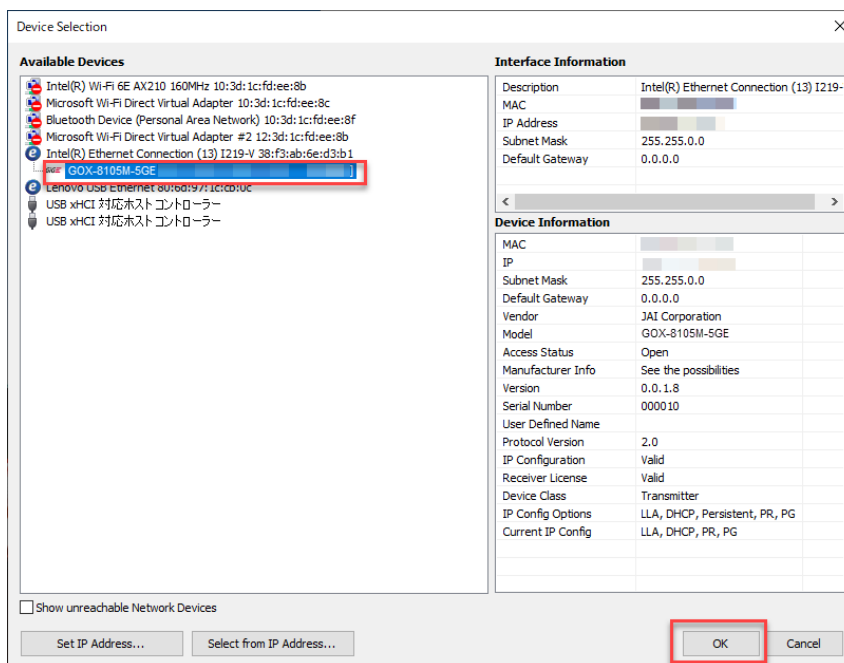

4. Check that the settings of the selected camera are displayed.

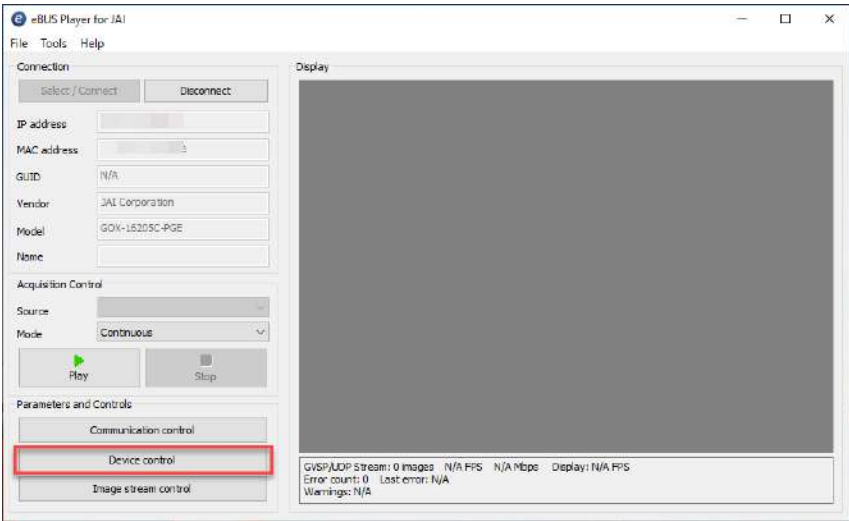

5. Click the **Device control** button. The screen shown below will be displayed. In this window, you can adjust various settings of the camera.

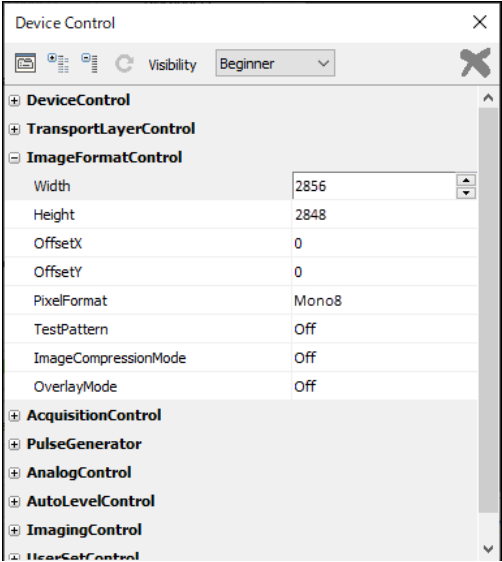

This completes the procedure for verifying whether the camera is properly recognized and whether control and settings configuration are possible.

Step 5: Change the Camera Settings

This section explains how to change settings by describing the procedure for changing the output format as an example.

Configure the Output Format

Configure the size, position, and pixel format of the images to be acquired. The factory settings are as follows. Change the settings as necessary.

Factory default values (GOX-8105M-5GE)

Item		Default Value
ImageFormatControl	Width	2856
	Height	2848
	OffsetX	0
	OffsetY	0
	PixelFormat	Mono8

Note: You can specify the image acquisition area. For details, see [“ROI Function \(Single ROI\)”](#).

Example: Configure the Width of ImageFormatControl

- By selecting the item of Width, you can change the value as shown below.

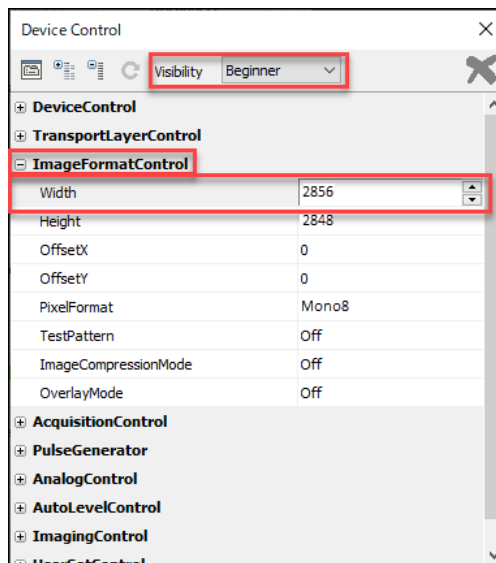

Note: Depending on the setting item, you need to change visibility. Please switch visibility (Beginner / Expert / Guru) as necessary.

Step 6: Adjust the Image Quality

Related Setting Items: [AnalogControl](#)

Display the camera image and adjust the image quality.

Display the Image

Display the image captured by the camera. When you click the **Play** button, the camera image appears in the right area.

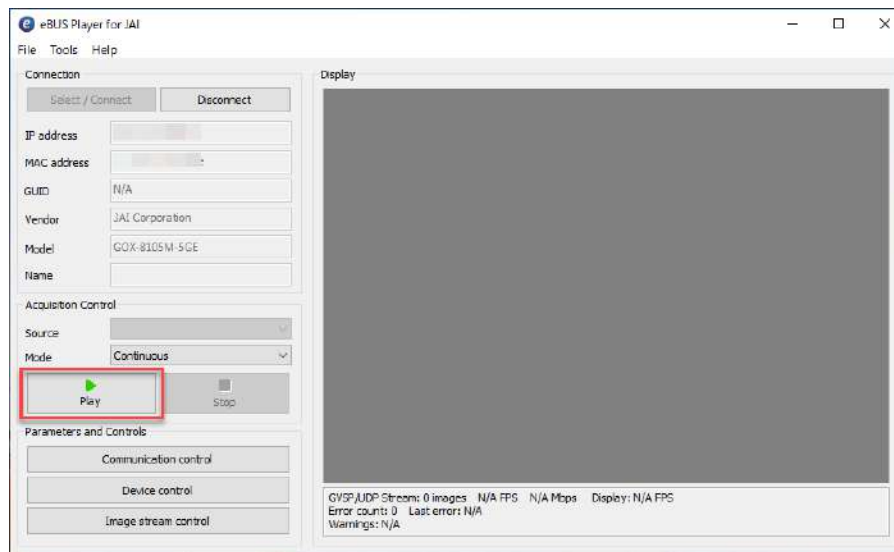

Note: It is recommended to set **GevGVCPPendingAck** in [TransportLayerControl](#) to **True**. When a time-consuming process such as white balance is performed, this camera returns an Ack response when the process is completed. In this case, some camera control software may cause a timeout error without waiting for an Ack response from the camera. When the **GevGVCPPendingAck** setting is enabled, if a time-consuming process is performed, the camera immediately returns a Pending Ack response and returns an Ack response when the processing is completed. The Timeout errors are prevented.

Adjust the Gain

Adjust the image quality using the gain and white balance functions. The Visibility must be changed from Beginner to **Guru**.

Note: For details on the Gain control, see [Gain Control](#) in the Main Functions chapter.

Manual Adjustment

1. Expand **AnalogControl**, and set GainAuto to **Off** (Default = Off).

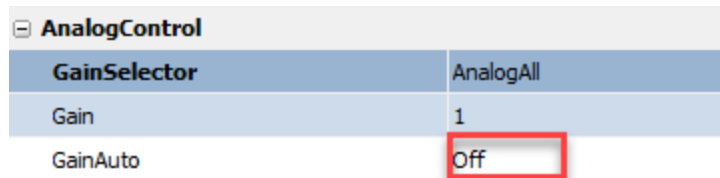

2. Select the gain you want to configure in GainSelector. AnalogAll (master gain), DigitalRed* (digital R gain), and DigitalBlue* (digital B gain) can be configured.

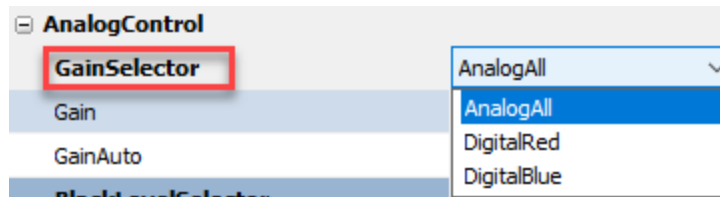

3. Configure the Gain.

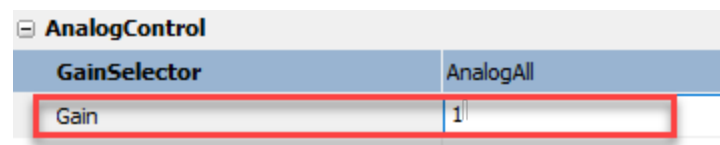

- DigitalAll (master gain) can be set to a value from x1 to x126 the analog gain value. The resolution is set in about 0.1dB steps. Values are configured by multipliers.
- The DigitalRed* (digital R gain) and DigitalBlue* (digital B gain) can be set to a value from x0.447 to x5.624. Values are configured by multipliers.

Note: *Color models only.

Adjust the White Balance

Adjust the white balance using the automatic adjustment function.

Note: The white balance is only supported on color models.

Automatic White Balance Adjustment

1. Place a white sheet of paper or similar object under the same lighting conditions as the intended subject, and zoom in to capture the white.

White objects near the subject, such as a white cloth or wall, can also be used. Be sure to prevent the high-intensity spotlights from entering the screen.

2. Select the **BalanceWhiteAuto** tab, and select **Continuous** or **Once** for the adjustment method.

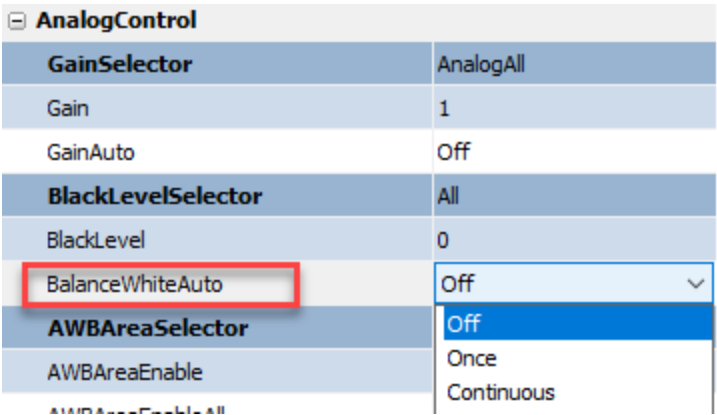

The white balance is automatically adjusted.

Note: For Continuous and Once, white balance is adjusted using R/B Gain.

Adjust the Black Level

- 1. Expand **AnalogControl**, and select the black level you want to configure in **BlackLevelSelector**. All (master black), Red* (digital R), and Blue* (digital B) can be configured.

Note: *Color models only.

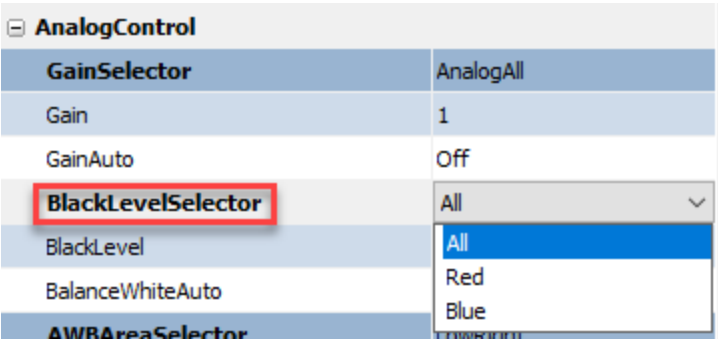

[-] AnalogControl	
GainSelector	AnalogAll
Gain	1
GainAuto	Off
BlackLevelSelector	All
BlackLevel	All
BalanceWhiteAuto	
AWBAreaSelector	

- 2. Specify the adjustment value in BlackLevel.

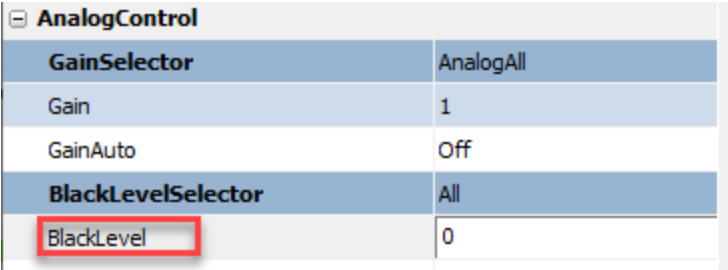

[-] AnalogControl	
GainSelector	AnalogAll
Gain	1
GainAuto	Off
BlackLevelSelector	All
BlackLevel	0

Step 7: Save the Settings

Related Setting Items: [UserSetControl](#)

The setting values configured in eBUS SDK for JAI will be deleted when the camera is turned off. By saving current setting values to user memory, you can load and recall them whenever necessary. You can save up to three sets of user settings in the camera. (User Set1 to 3)

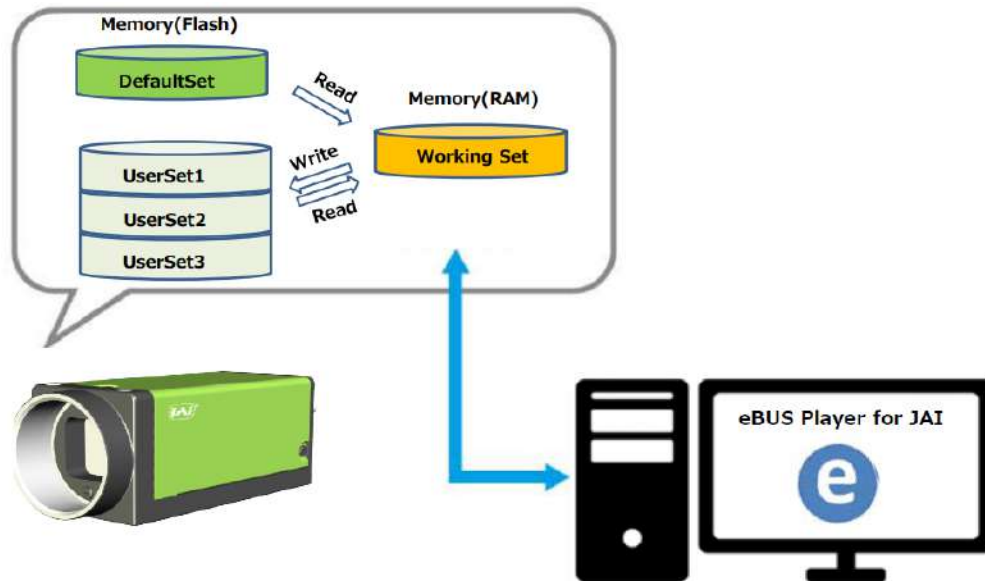

Note: Changes to settings are not saved to the computer (eBUS SDK for JAI).

To Save User Settings

1. Stop image acquisition.
2. Expand **UserSetControl**, and select the save destination (UserSet1 to UserSet3) in UserSetSelector.

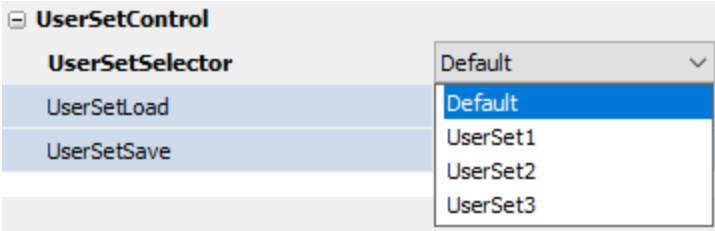

Note: The factory default setting values are stored in Default and cannot be overwritten.

Caution: Settings can only be saved when image acquisition on the camera is stopped.

3. Select **UserSetSave**, and click the **UserSetSave** button.

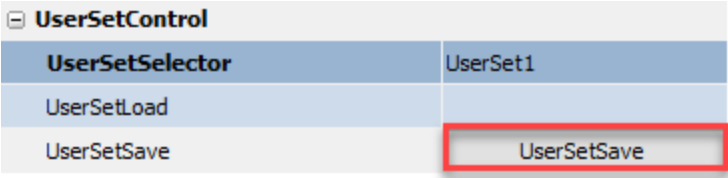

4. The current setting values are saved as user settings.

To Load User Settings

1. Stop image acquisition. User settings can only be loaded when image capture on the camera is stopped.
2. Select the settings to load (UserSet1 to UserSet3) in UserSetSelector.

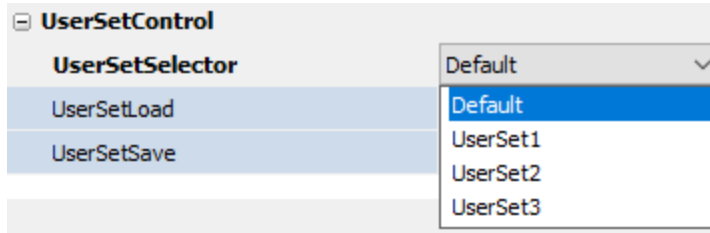

3. Select **UserSetLoad**, and click the **UserSetLoad** button.

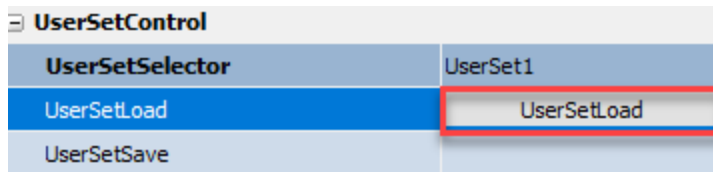

4. The selected user settings are loaded.

Note: When selecting **Default** for UserSetSelector, the factory settings are loaded.

Main Functions

This chapter describes the camera's main functions.

Acquisition Control

Related Setting Items: [AcquisitionControl](#)

This camera has three Acquisition modes (SingleFrame, MultiFrame, Continuous). Use the AcquisitionControl settings to perform operations and settings for image capture.

SingleFrame

When the AcquisitionStart command is executed, one frame of image is captured.



MultiFrame

When the AcquisitionStart command is executed, the number of frames set in AcquisitionFrameCount are acquired as images.

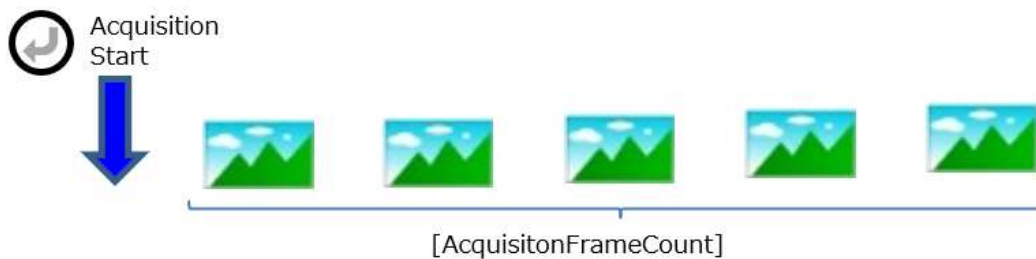

Continuous

When the AcquisitionStart command is executed, images will continue to be acquired until the AcquisitionStop command is executed.



Note: After changing various settings, the black level may not be stable for several frames immediately after AcquisitionStart.

Changing the Frame Rate

When TriggerMode is disabled, you can change the frame rate in AcquisitionFrameRate.

The shortest frame period varies depending on the Width, Height, PixelFormat, SensorDigitizationBits, Binning(Horizontal/Vertical), FD2x2BinningMode, ImageScalingMode, Decimation (Horizontal/Vertical), ChunkModeActive, GevSCPSPacketSize, GevSCPD, NetworkThroughputSafetyMargin settings.

The NetworkThroughputSafetyMargin setting (in [TransportLayerControl](#)) controls how much of the available GigE Vision bandwidth can be used to transmit image data. The default value is 92 (percent). You can shorten the frame period (increase the frame rate) by increasing this value, however at values above 92, abnormal images may be observed. If abnormal images are observed, lower the value.

The longest frame period is 0.125 Hz (8 sec.).

Note: When TriggerMode[FrameStart] is enabled, the AcquisitionFrameRate setting is disabled.

Exposure Mode

Related Setting Items: [AcquisitionControl](#)

This camera has three Exposure modes (Off, Timed, TriggerWidth). Use the AcquisitionControl settings to perform operations and settings for exposure.

■ ExposureMode = Off

Exposure control is not performed (free-running operation). The exposure time is the longest possible time within the operating conditions such as the frame rate.

■ ExposureMode = Timed

Mode in which control is performed using ExposureTime. Acquire images using an exposure time configured beforehand on an external trigger.

In this mode, the exposure time can be adjusted automatically by setting ExposureAuto. For details, refer to [ALC \(Automatic Level Control\) Function](#).

■ ExposureMode = TriggerWidth

Mode in which control of the exposure time is performed using the pulse width of the trigger input signal. The exposure time will be the same as the pulse width of the trigger input signal.

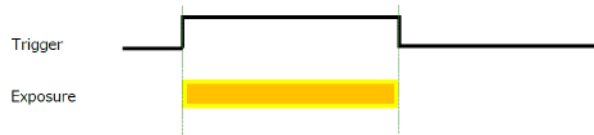

Notes:

- The settings for exposure control and triggers are related to each other. Be sure to configure the settings described in [Trigger Control](#).
- When exposed to strong light, the accumulation time may appear to shift due to PLS (Parasitic Light Sensitivity) and other effects.

Actual Exposure Time

Related Setting Items: [AcquisitionControl](#)

When ExposureMode is set to **Timed**, the actual exposure time will consist of the image sensor's offset duration (2.45us) added to the ExposureTime setting configured on the camera.

Actual Exposure Time: *ExposureTime* value (us) + 2.45us

Note: On this camera, the ExposureActive signal's pulse width includes the Exposure offset duration (2.45us). Therefore, "ExposureActive signal's pulse width = *ExposureTime* value (us) + 2.45(us)."

RCT Mode

Related Setting Items: [AcquisitionControl](#)

In RCT mode, the image is not output from the camera until FrameStartTrigger is input, but internally the imaging operation is continued and the automatic gain control (AGC) function, the automatic shutter control (ASC) function and the automatic white balance (AWB) function can be continued.

You can use RCT mode when:

- **ExposureMode** is set to **Timed**, and **FrameStartTriger** is set to **On**.
- [Sequencer Function](#) = **Off**
- **AcqusitionMode** = **Continuous**

Trigger Control

Related Setting Items: [AcquisitionControl](#)

The camera allows the following controls to be performed via external trigger signals.

TriggerSelector	Description																																															
AcquisitionStart	Start image acquisition in response to the external trigger signal input.																																															
AcquisitionEnd	Stop image acquisition in response to the external trigger signal input.																																															
FrameStart	<p>Start capturing a one-frame image in response to the external trigger signal input. Select this to perform exposure control using external triggers.</p> <p>Note: The FrameStart Trigger can only be used when the Exposure Mode setting is set to Timed.</p>																																															
AcquisitionTransferStart	<p>Start output of acquired image data in response to external trigger signal input (delayed readout). The number of frames that can be acquired depends on the model and Pixel Format setting.</p> <p style="text-align: center;">Number of Frames That Can Be Acquired (Full ROI)</p> <table border="1" style="width: 100%; border-collapse: collapse;"> <thead> <tr> <th rowspan="2"></th> <th colspan="5">PixelFormat</th> </tr> <tr> <th>Mono8 Bayer8</th> <th>Mono10Packed Mono12Packed Bayer10Packed Bayer12Packed</th> <th>Mono10 Mono12 Bayer10 Bayer12</th> <th>RGB8</th> <th>RGB10V1Packed RGB10p32</th> </tr> </thead> <tbody> <tr> <td>GOX-5105MC-5GE</td> <td>25</td> <td>16</td> <td>12</td> <td>8</td> <td>6</td> </tr> <tr> <td>GOX-8105MC-5GE</td> <td>15</td> <td>10</td> <td>7</td> <td>5</td> <td>3</td> </tr> <tr> <td>GOX-12405MC-5GE</td> <td>10</td> <td>6</td> <td>5</td> <td>3</td> <td>2</td> </tr> <tr> <td>GOX-16205MC-5GE</td> <td>7</td> <td>5</td> <td>3</td> <td>2</td> <td>1</td> </tr> <tr> <td>GOX-20405MC-5GE</td> <td>6</td> <td>4</td> <td>3</td> <td>2</td> <td>1</td> </tr> <tr> <td>GOX-24505MC-5GE</td> <td>5</td> <td>3</td> <td>2</td> <td>1</td> <td>1</td> </tr> </tbody> </table> <p>Notes: The number of MAX frames that can be acquired depends on the PayloadSize per frame; therefore, in addition to the PixelFormat setting, the below settings will also affect the number of frames that can be acquired (including cases where the below settings are changed due to changes of other setting items).</p> <ul style="list-style-type: none"> • Width (ImageFormatControl) • Height (ImageFormatControl) • ChunkModeActive (ChunkDataControl) 		PixelFormat					Mono8 Bayer8	Mono10Packed Mono12Packed Bayer10Packed Bayer12Packed	Mono10 Mono12 Bayer10 Bayer12	RGB8	RGB10V1Packed RGB10p32	GOX-5105MC-5GE	25	16	12	8	6	GOX-8105MC-5GE	15	10	7	5	3	GOX-12405MC-5GE	10	6	5	3	2	GOX-16205MC-5GE	7	5	3	2	1	GOX-20405MC-5GE	6	4	3	2	1	GOX-24505MC-5GE	5	3	2	1	1
	PixelFormat																																															
	Mono8 Bayer8	Mono10Packed Mono12Packed Bayer10Packed Bayer12Packed	Mono10 Mono12 Bayer10 Bayer12	RGB8	RGB10V1Packed RGB10p32																																											
GOX-5105MC-5GE	25	16	12	8	6																																											
GOX-8105MC-5GE	15	10	7	5	3																																											
GOX-12405MC-5GE	10	6	5	3	2																																											
GOX-16205MC-5GE	7	5	3	2	1																																											
GOX-20405MC-5GE	6	4	3	2	1																																											
GOX-24505MC-5GE	5	3	2	1	1																																											

Notes:

- The settings for exposure control and triggers are related to each other. Be sure to configure the settings described in [Exposure Mode](#).
- You can delay when exposure actually starts after a trigger is received for a specific amount of time by configuring **TriggerDelay**.

Select the trigger type with TriggerSelector, and set the following items for each trigger.

TriggerMode	Switch enable or disable.
TriggerSource	Select the source signal (PulseGenerator0-3, UserOutput0-3, Action0-3, Software, Line5 Opt In, Nand0 Out, Nand1 Out). Note: Trigger can be executed by TriggerSoftware[TriggerSelector] command only when Software is set.
TriggerActivation	Sets the polarity of the trigger signal.
TriggerDelay	You can specify a delay after receiving the trigger signal until the trigger is enabled. Note: This trigger type is available only when TriggerSelector is set to FrameStart .

When Using the FrameStart Trigger

When AcquisitionStart is executed and a FrameStart trigger is received before the AcquisitionStop command is executed, one frame is acquired.

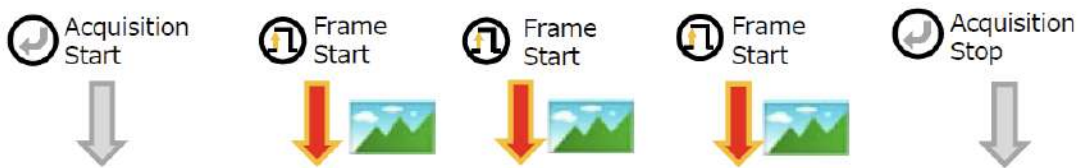

The source signals that can be set for the AcquisitionStart, AcquisitionEnd, FrameStart, and AcquisitionTransferStart triggers are as follows:

- Software, PulseGenerator 0 – 3, UserOutput 0 – 3, Action 0 – 3, Line5 Opt In 1, NAND0 Out, and NAND1 Out.

■ FrameStart and AcquisitionTransferStart Triggers

On this camera, when **AcquisitionTransferStart** is set to **On**, the camera expects that the number of **AcquisitionTransferStart** trigger inputs is the same as the number of **FrameStart** trigger inputs. Otherwise, a GVSP error may occur.



For example, if the FrameStart trigger is issued 100 times but the AcquisitionTransferStart trigger is issued only once, the camera attempts to send the first frame, but a GVSP Error will be sent instead because the first frame is already discarded. The below shows an example of when the camera can hold up to 10 frames in the frame memory.

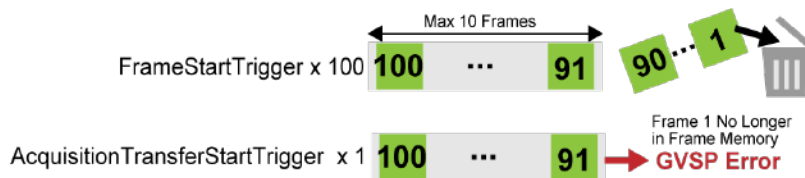

To output an image, the AcquisitionTransferStart trigger must be issued continuously until it reaches the number of frames in the frame memory. For example, if 10 frames remain in the frame memory, the AcquisitionTransferStart trigger must be issued 90 more times to output the image.

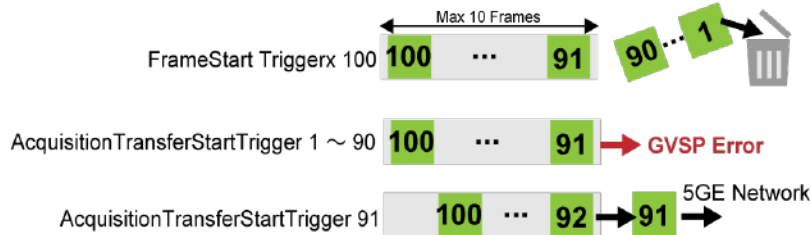

Pixel Format

Related Setting Items: [ImageFormatControl](#)



Technical Notes

Pixel Format Alignments for GigE Vision

Selectable PixelFormat is as follows.

Color models	BayerRG8 (default), BayerRG10, BayerRG10Packed, BayerRG12, BayerRG12Packed, BayerGR8*, BayerGR10*, BayerGR10Packed*, BayerGR12*, BayerGR12Packed*, BayerGB8*, BayerGB10*, BayerGB10Packed*, BayerGB12*, BayerGB12Packed*, BayerBG8*, BayerBG10*, BayerBG10Packed*, BayerBG12*, BayerBG12Packed*, RGB8, RGB10V1Packed, RGB10p32 Note: *When using ReverseX, ReverseY.
Mono models	Mono8 (default), Mono10, Mono10Packed, Mono12, Mono12Packed

Notes:

On color models, the Bayer array is changed by the [Image Flip Function](#).

- ReverseX : 0 (False), ReverseY : 0 (False) -> BayerRG
- ReverseX : 0 (False), ReverseY : 1 (True) -> BayerGB
- ReverseX : 1 (True), ReverseY : 0 (False) -> BayerGR
- ReverseX : 1 (True), ReverseY : 1 (True) -> BayerBG

SensorDigitizationBits

Related Setting Items: [ImageFormatControl](#)

You can use SensorDigitizationBits to select the sensor output bits for this camera (8bits, 10bits, and 12bits: default = 10bits).

Notes:

- When SensorDigitizationBits is set to "8Bits", the sensitivity is 4 times higher than when set to 10Bits/12Bits.
- If SensorDigitizationBits is set to smaller than the pixel format bits configured in the [Pixel Format](#), the image may have gaps in histogram.
- When [Gradation Compression Mode](#) is set to On, SensorDigitizationBits is not configurable (maintains 10bits or 12bits).

Image Flip Function

Related Setting Items: [ImageFormatControl](#)

Using this function, you can output the image by inverting it horizontally and/or vertically.

In the ImageFormatControl settings,

- To reverse the image horizontally, set ReverseX to True.
- To reverse the image vertically, set ReverseY to True.

On color models, the Bayer array is changed by the Image Flip function.

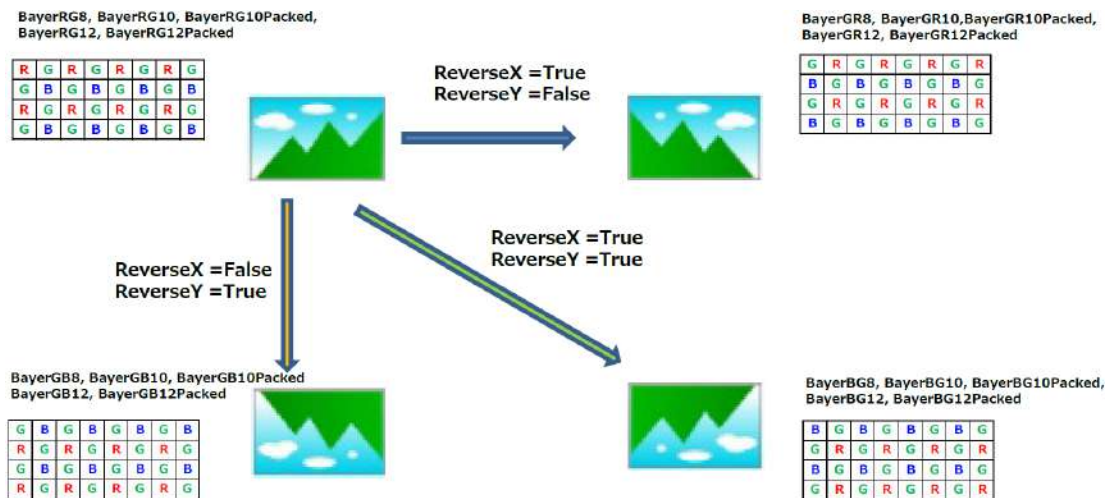

GPIO (Digital Input/Output Settings)

Related Setting Items: [DigitalIOControl](#)

The camera can input/output the following signals to and from external input/output connectors.

External Output	Line2 : Opt Out	DC IN / TRIG IN Connector (6-pin round)
Internal Output	Line5 : Opt In	DC IN / TRIG IN Connector (6-pin round)

These signals can be used as triggers and other necessary signals within the camera or as signals output from the camera to the system, such as those used for lighting equipment control.

Use the [DigitalIOControl](#) to set the digital input/output. Select input or output in LineSelector, you can check LineMode, LineFormat, and set LineInverter. You can also check the status of each digital I/O as shown in the table below with LineStatusAll.

LineSelector	LineMode	LineFormat	LineInverter	LineStatusAll	
Line2 (Opt Output1)	Output	OptCoupled	True/False	bit1	DC IN / TRG IN connector
Line5 (Opt In 2)	Input	OptCoupled	False (fixed)	bit4	DC IN / TRG IN connector
Nand0In1	Input	InternalSignal	True/False	bit12	
Nand0In2	Input	InternalSignal	True/False	bit13	
Nand1In1	Input	InternalSignal	True/False	bit14	
Nand1In2	Input	InternalSignal	True/False	bit15	
TimestampReset	Internal Connection	InternalSignal	False (fixed)		

For digital output, set the output source signal using LineSource. Set the source signal in the same way for NAND Logic (Nand0In1, Nand0In2, Nand1In1, Nand1In2) and TimestampReset.

The table below shows the source signals that can be set.

LineSelector	Off	AcquisitionActive	FrameActive	ExposureActive	FVAL	LVAL	PulseGenerator0	PulseGenerator1	PulseGenerator2	PulseGenerator3	UserOutput0	UserOutput1	UserOutput2	UserOutput3	Action0	Action1	Action2	Action3	Lines Opt In1	NAND0 Out	NAND1 Out	Low	High	AcquisitionTriggerWait	FrameTriggerWait
Line2		✓	✓	✓	✓		✓	✓	✓	✓	✓	✓	✓	✓					✓	✓	✓	✓	✓	✓	✓
Line5																									
Nand0In1		✓	✓	✓	✓		✓	✓	✓	✓	✓	✓	✓	✓					✓		✓	✓	✓	✓	✓
Nand0In2		✓	✓	✓	✓		✓	✓	✓	✓	✓	✓	✓	✓					✓		✓	✓	✓	✓	✓
Nand1In1		✓	✓	✓	✓		✓	✓	✓	✓	✓	✓	✓	✓					✓	✓		✓	✓	✓	✓
Nand1In2		✓	✓	✓	✓		✓	✓	✓	✓	✓	✓	✓	✓					✓	✓		✓	✓	✓	✓
TimestampReset	✓						✓	✓	✓	✓	✓	✓	✓	✓	✓	✓	✓	✓	✓	✓	✓	✓	✓		

VideoProcessBypassMode

Related Setting Items: [ImagingControl](#)

The video process bypass mode is a function that bypasses internal video processing on the camera. To use this function, VideoProcessBypassMode must be set to On.

Functions Unavailable in VideoProcessBypassMode

Gain[DigitalRed][DigitalBlue], BlackLevel, BalanceWhiteAuto, LUTMode, EdgeEnhancer, ShadingControl, SequencerGainDigitalRed/Blue, SequencerLutEnable

Gain Control

Related Setting Items: [AnalogControl](#)

Adjust the overall gain with AnalogAll (master gain), and adjust the white balance by changing DigitalRed and DigitalBlue.

Color Model

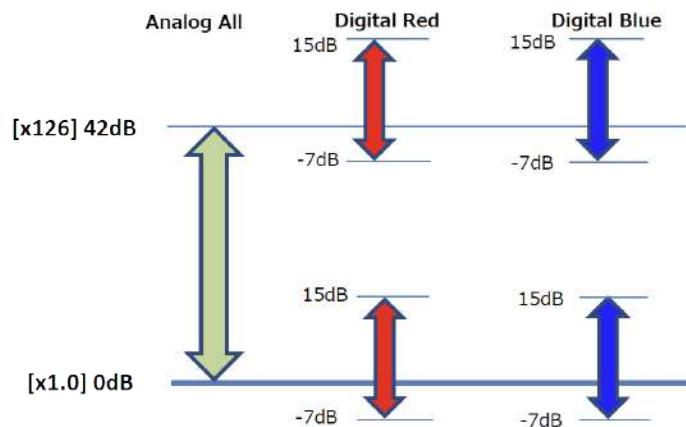

Monochrome Model

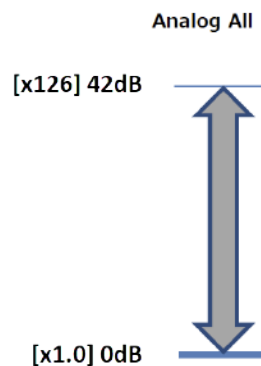

Automatic Gain Level Control

Set GainAuto to **Continuous** to control the gain level automatically.

When GainAuto is set to **Continuous**, you can configure the conditions for automatic adjustment in detail.

- When GainAuto is set to **Continuous**, the automatic adjustment will be performed continuously.
- When GainAuto is set to **Once**, the automatic adjustment will be performed only once.

White Balance

Related Setting Items: [AnalogControl](#)

To adjust the white balance automatically, set BalanceWhiteAuto to **Once** (automatic adjustment only once) or **Continuous** (automatic adjustment always).

The metering area can be limited for automatic adjustment. To limit the metering area, specify each of the 16 areas with AWBAreaSelector and set AWBAreaEnable to True or False.

16 Areas

HighLeft	HighMidLeft	HighMidRight	HighRight
MidHighLeft	MidHighMidLeft	MidHighMidRight	MidHighRight
MidLowLeft	MidLowMidLeft	MidLowMidRight	MidLowRight
LowLeft	LowMidLeft	LowMidRight	LowRight

In addition, the white balance has been adjusted in advance for specific color temperature lighting. It is possible to select from the following four presets. (Color temperature for preset : 3200K, 5000K, 6500K, 7500K)

Color Temperature

The adjustable range of white balance for this camera is 3000K to 9000K.

Please refer to the figure below for an overview of the relationship between various lighting types and color temperature.

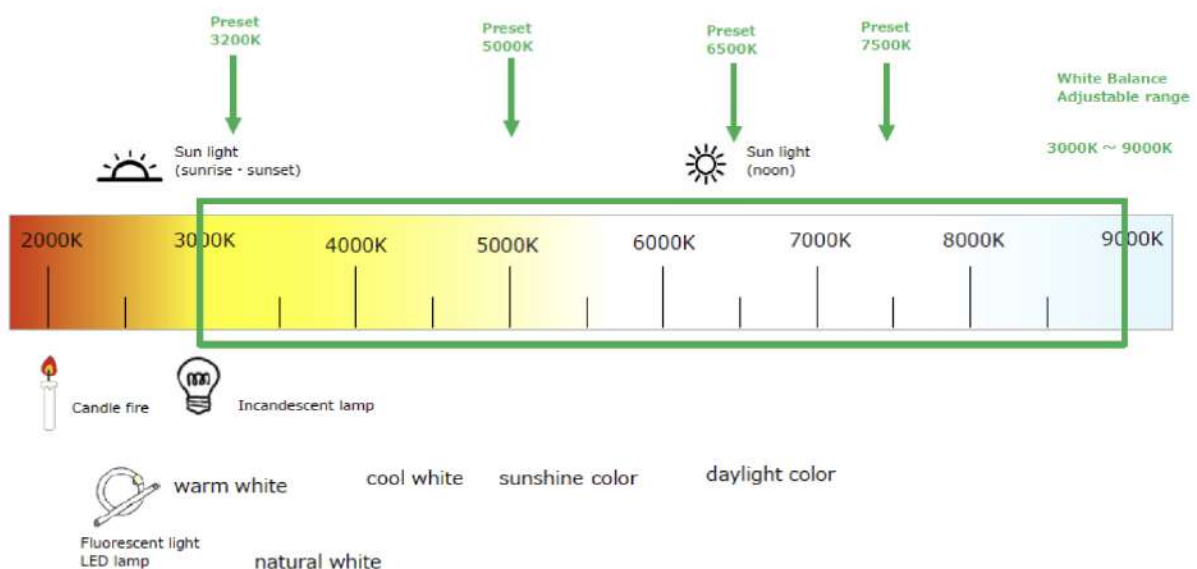

ALC (Automatic Level Control) Function

Related Setting Items: [AutoLevelControl](#)

The ALC (automatic level control) function combines the automatic gain control (AGC/Auto Gain Control) and automatic exposure control (ASC/Auto Shutter Control) functions and is capable of handling various changes in brightness. The function operates as follows in response to changes in brightness.

Change from bright to dark: ASC → AGC

Change from dark to bright: AGC → ASC

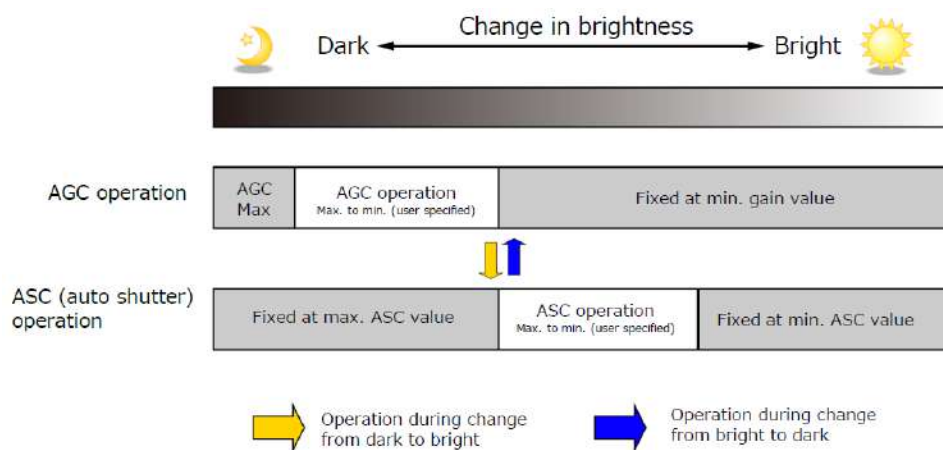

To Use the ALC Function

Set GainAuto or ExposureAuto or both to **Continuous** mode. Configure the minimum value, maximum value, etc. for AGC and ASC in AutoLevelControl.

The target video levels for AGC and ASC are configured in ALCCReference. For example, when ALCCReference is set to 95%, video levels will be maintained at 95% using AGC and ASC.

In color models, the channel to be used as the reference for ALC control can be set.

- **ALCCControlReference:** Set whether to specify the SelectedChannel refer to channel (R, G, B) or PeakChannel refer to the channel with the highest average image level.
- If ALCCControlReference= SelectedChannel, set ALCCControlChannel to **Red**, **Green** or **Blue**.

The speed of ALC control can be set from 1 to 100 (fastest) in ALCCControlRatio.

Note: If the ALCCControlRatio setting is large, the ALC operation may cause hunting depending on the AcquisitionFrameRate setting. In this case, lower the value of AcquisitionFrameRate or ALCCControlRatio.

Gamma Function

Related Setting Items: [AnalogControl](#)

The Gamma function corrects the output signals from the camera beforehand (reverse correction), taking into consideration the light-emitting properties of the monitor display. As the light-emitting properties of the monitor are not linear, the entire image may be darker or the gradation in the dark areas may be less noticeable when camera outputs are displayed without processing.

The Gamma function can be used to correct the camera signals with an opposite-direction curve and produce a display that is close to linear.

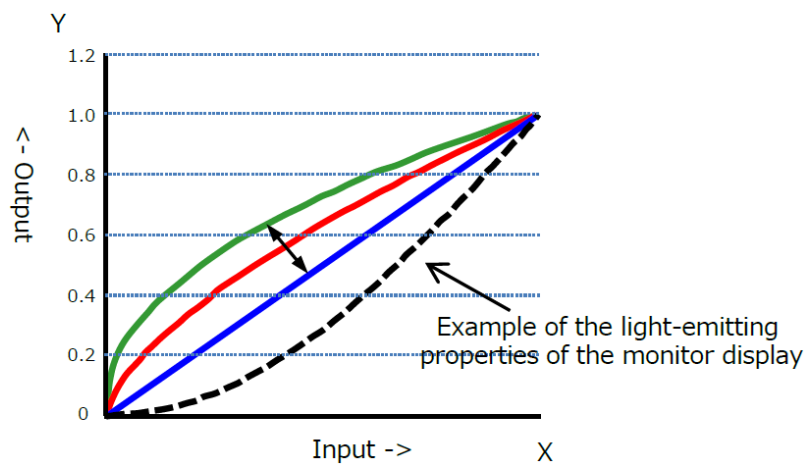

To Use the Gamma Function

Configure the settings as follows.

Item	Setting Value / Selectable Range	Description
Gamma	0.45, 0.5, 0.55, 0.6, 0.65, 0.75, 0.8, 0.9, 1.0	Select the Gamma correction value.
LUTMode	Gamma	Use Gamma.

Note: You can use the LUT function to configure a curve with more detailed points. For details, see [LUT \(Lookup Table\)](#).

LUT (Lookup Table)

Related Setting Items: [LUTControl](#)

The LUT function is used to generate a non-linear mapping between signal values captured on the sensor and those that are output from the camera. You can specify the output curve using 257 setting points (indexes).

To Use the LUT Function

Configure the settings as follows.

Item	Setting Value / Selectable Range	Description
LUTMode	LUT	Use LUT.
LUTSelector	Red, Green, Blue	Select the LUT channel to control (Color models only).
LUTIndex	0 ~ 256	Select the LUT index to configure. Indexes represent the possible pixel values captured on the sensor, from the lowest value (Index 0) to the highest (Index 256). For example, Index 0 represents a full black pixel and Index 256 represents a full white pixel.
LUTValue	0 ~ 4095	Set the LUT output value for the selected index.

LUT Value

LUT values range from 0 at the lowest to 4095 at the highest. Linear interpolation is used to calculate LUT values between the index points.

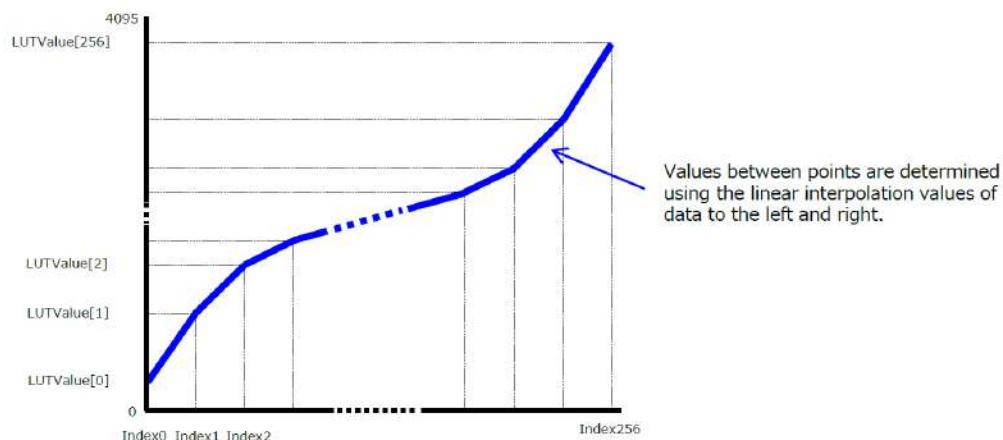

BlemishCompensation

Related Setting Items: [BlemishControl](#)

Multiple defective pixels that are not adjacent to each other can occur on CMOS sensor cameras.

This camera features a function that interpolates defective pixels using the surrounding pixels. Up to 2000 pixels can be corrected. Pixel interpolation can be performed via automatic detection or point-by-point manual settings.

Automatic Detection

Automatic detection can only detect lit defective pixels (i.e., white blemishes).

1. Shield the camera sensor. If a lens is attached, use the lens cap as a shield, for example.
2. Configure the threshold level for defective pixel detection with **BlemishDetectThreshold**.
 - Up to 2000 pixels can be corrected.
 - The threshold value is specified as a percentage.
 - The default setting is "10" with 10% of the full scale (100%) specified as the threshold value.
3. Execute **BlemishDetect** to start automatic detection. After detection, the interpolation data is saved to the camera's internal memory.

To check the number of interpolated pixels after automatic detection

You can check the number of pixels interpolated via automatic detection by loading the BlemishNum data.

Notes:

Automatic detection will not be executed when:

- No image is being output.
- TestPattern is being output
- In Sequencer Mode ([Sequencer Function](#))
- In MultiRoi mode ([ROI Function \(Multi ROI\)](#))
- The image is not full ROI size ([ROI Function \(Single ROI\)](#))
- In Reverse mode ([Image Flip Function](#))
- GradationCompressionMode is not Off ([Gradation Compression Mode](#))
- AcquisitionMode is not Continuous ([Acquisition Control](#))
- Not in lens cap state

Manual Configuration

1. Select the **index** in **BlemishCompensationIndex**. You can select from 1 to 2000. However, configure the indexes in order starting with the smallest index. If you skip indexes while configuring settings, interpolation may not be performed.
2. Specify the pixel points for interpolation using the **BlemishCompensationPositionX** and **BlemishCompensationPositionY** settings.

Notes:

- You can configure values that are within the total effective pixel area. Specify pixels for which interpolation is not necessary as -1. If 0 is specified, the first line or first pixel will be interpolated.
- To delete the configured pixel points, execute **BlemishCompensationDataClear** with the corresponding index selected.

3. Execute **BlemishStore**. Blemish compensation data will be stored.
4. Set BlemishEnable to **Enable**, and execute interpolation. If it is set to **Disable all**, all interpolation for defective pixels will be disabled (including the factory-set interpolation data). If set to **Disable user detection**, the factory-set interpolation data remains valid, and only the interpolation data registered in **BlemishCompensationIndex** is disabled.

Shading Correction

Related Setting Items: [ShadingControl](#)

The ShadingCorrection function corrects non-uniformity (i.e., shading) in the amount of light generated by the lens and lighting equipment. Using this function allows correction even if top, bottom, left, and right shading is not symmetrical in relation to the center of the screen (H, V).

This function can be used even when the effective image area is limited (an area with both Width and Height set to more than 512 must be configured) by the [ROI Function \(Single ROI\)](#). In such cases, the correction area is included in the image area configured by the ROI.

Block size is 128 × 128 pixels.

The following shading correction modes are available on the camera.

■ FlatShading (Monochrome model, Color model)

Correction is performed using the area of the screen with the highest brightness level as the reference, and adjusting the brightness levels of the other areas to match this level.

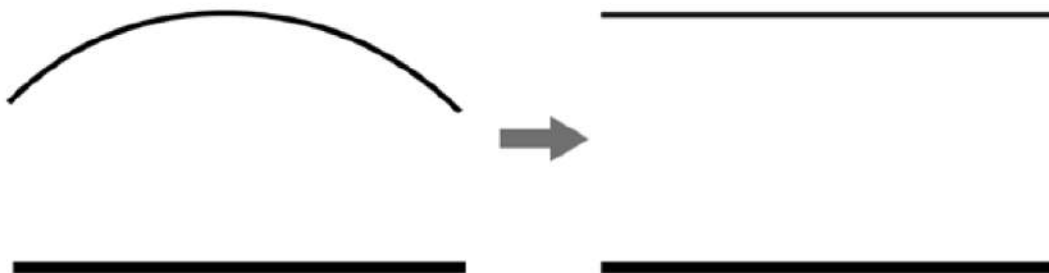

■ ColorShading (Color models only)

R-channel and B-channel properties are adjusted to using the G-channel shading properties as a reference.

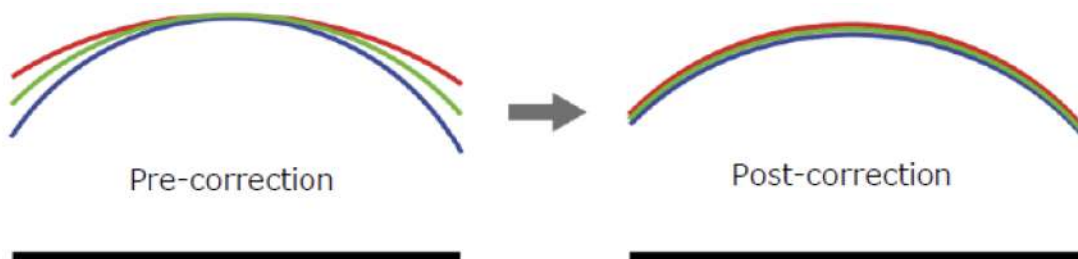

Cautions:

- For FlatShading and ColorShading, the maximum amount of correction gain for all pixels is limited to 8 times the amount of gain before correction. (The amount of gain cannot be increased to more than 8 times the amount of gain from before correction.)
- If the area in the screen with the highest brightness level is 1000 LSB or higher (during 10-bit video output), or if the lowest brightness level is less than 45 LSB (during 10-bit video output), proper correction is not possible.

To Use the Shading Correction Function

Configure the settings as follows.

Item	Setting Value	Description
ShadingCorrectionMode	FlatShading, ColorShading	Select the shading correction mode.
ShadingMode	User1, User2, User3, Off	Select the user area to which to save the shading correction value.

Display a white chart under a uniform light, and execute **PerformShadingCalibration**.

Notes:

- After shading correction is executed, the shading correction value is automatically saved to the user area selected in ShadingMode.
- The PerformShadingCalibration command cannot be executed under the following conditions. (An error also occurs when ShadingMode is set to Off).
 - When outputting no image.
 - When outputting TestPattern.
 - Width and/or Height are less than 512 ([ROI Function \(Single ROI\)](#))
 - In FD2x2Binning mode ([Binning Function](#))
 - In ImageScaling mode ([Image Scaling Mode \(Xscale\)](#))
 - In Decimation mode ([Decimation Mode](#))
 - In Sequencer mode ([Sequencer Function](#))
 - In MultiRoi mode ([ROI Function \(Multi ROI\)](#))
 - In Reverse mode ([Image Flip Function](#))
 - In GradationCompression mode ([Gradation Compression Mode](#))
 - In ALC mode ([ALC \(Automatic Level Control\) Function](#))
 - AcquisitionMode is set to other than Continuous ([AcquisitionControl](#))

Binning Function

Related Setting Items: [ImageFormatControl](#)

The Binning function allows you to combine the signal values of clusters of adjacent pixels to create improved virtual pixels. Using the function results in images with a lower pixel resolution and higher sensitivity in summing mode or reduced noise in averaging mode.

This camera model supports the following binning modes:

- **FD2x2BinningMode**
Performs Horizontal x2 and Vertical x2 analog binning (Sum).
- **BinningHorizontal, BinningVertical**
Performs Horizontal x2 and/or Vertical x2 digital binning (Sum or Average).

Notes:

- Monochrome models only.
- Refer to [Functions That Cannot Be Used Together](#) for usage restrictions.

How to Configure

When configuring **FD2x2BinningMode**, set the setting to **On**. When configuring **BinningHorizontal/BinningVertical**, set the setting to **2**.

Note: **FD2x2BinningMode** and **BinningHorizontal/ BinningVertical** cannot be used together.



	Binning off	2 x 1	1 x 2	2 x 2
				
FD2x2BinningMode	OFF	N/A	N/A	ON
BinningHorizontal	1	2	1	2
Binning Vertical	1	1	2	2

Image Scaling Mode (Xscale)

Related Setting Items: [ImageFormatControl](#)

JAI's Xscale algorithm digitally reduces the sensor image by specifying the vertical and horizontal scaling ratio. This function can also be used for color models and allows finer adjustment of resolution than the conventional [Binning Function](#).

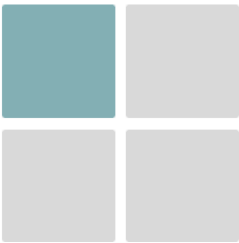
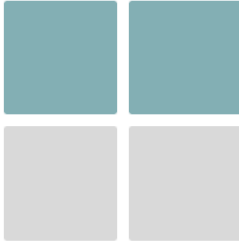
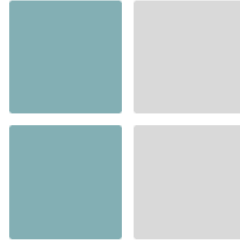
The output image types are Average or Sum.

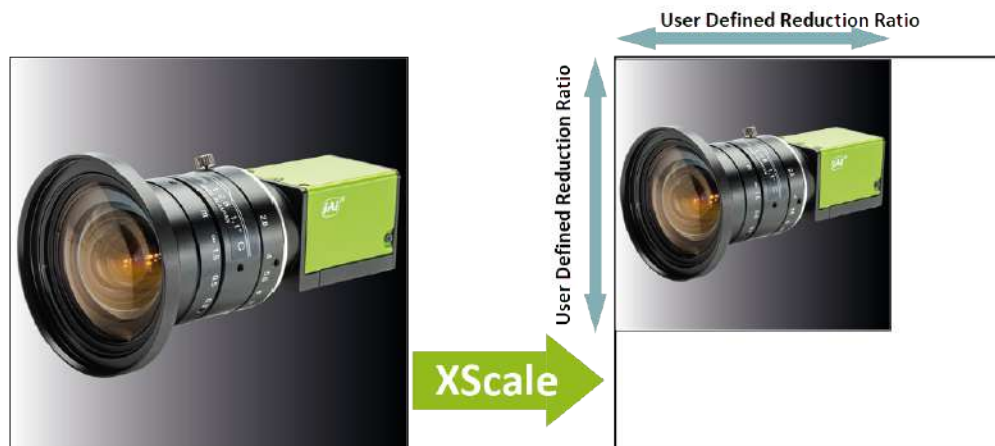

Notes:

- When using this function with the [ROI Function \(Single ROI\)](#), first, set the Width, Height, OffsetX, and OffsetY settings, and then configure the Image Scaling Mode settings.
- Refer to [Functions That Cannot Be Used Together](#) for usage restrictions.

How To Configure

1. If necessary, configure the [ROI Function \(Single ROI\)](#) settings.
2. Set ImageScalingMode (ImageFormatControl) to **On**.
3. Use **ImageScalingSumMode** to specify the output image mode. The options are "**Average** (Off)" or "**Sum** (On)." Depending on the mode, the output image's brightness will be different.

Average Mode: The average brightness of the sensor image is equal to the average brightness of the reduced output image.

Sum Mode: The sum of the brightness of all pixels in the sensor image and the sum of the brightness of all pixels in the reduced output image is equal, thus increasing the brightness of the output image.

4. Use **ImageScalingHorizontal** and **ImageScalingVertical** to specify the horizontal and vertical scaling ratio. For more information on how to specify the scaling ratio, see [Specifying the Scaling Ratio](#).

Specifying the Scaling Ratio

Specify the scaling ratio in decimal point (maximum six decimal places) for **ImageScalingHorizontal** and **ImageScalingVertical**. The setting range is 0.0625 to 1. If "1" is specified, the image will not be scaled.

Caution: Xscale automatically rounds down the width to the nearest value that is a multiple of 4 and rounds down the height to the nearest value that is a multiple of 2.

Note: When using Xscale, the horizontal and vertical scaling factors determine the size of the virtual pixels in the scaled image. This information, plus any ROI that has been preset by the user, determines the maximum number of whole virtual pixels possible in the output image.

Example 1

If you want to output an image with 50% scaling both horizontally and vertically, set **ImageScalingHorizontal** and **ImageScalingVertical** to "0.5". (This is equivalent to the traditional 2 x 2 binning.)



Example 2

When you are replacing your camera with a new one but the new camera has a different pixel size and resolution, you can reproduce the current camera's pixel size and output image size on the replacement camera, using the [ROI Function \(Single ROI\)](#) and **ImageScalingMode** functions.

This example shows how to configure the ROI and **ImageScalingMode** settings when replacing the GOX-2402C camera with the GOX-5105C camera.

	Pixel Size	Full Resolution (Width x Height)
Current Camera: GOX-2402C	3.45 μm x 3.45 μm	1920 x 1200
New Camera: GOX-5105C	2.74 μm x 2.74 μm	2472 x 2064

1. First, find the scaling ratio for the ROI. To make the virtual pixel size of the new camera (GOX-5105C) the same size as the current camera (GOX-2402C), the scaling ratio is "0.79" ($2.74 \div 3.45 = 0.79$).
2. Next, configure the ROI settings for the new camera (GOX-5105C). Set the new camera's **Width** and **Height** (ImageFormatControl) as follows:
 - a. Width: $1920 \div 0.79 = 2430$. However, since the ROI Width Step is 4, set Width to "2432".
 - b. Height: $1200 \div 0.79 = 1519$. However, since the ROI Height Step is 2, set Height to "1520".

Note: If the specified ROI is larger than the supported resolution of the replacement camera, you will need to switch to a replacement camera with a higher resolution.

3. Turn the new camera's **ImageScalingMode On**.
4. Set **ImageScalingHorizontal** and **ImageScalingVertical** to "0.789474" ($1920 \div 2432 = 0.789474$ and $1200 \div 1520 = 0.789474$).

Note: ImageScalingHorizontal and ImageScalingVertical can be set up to 6 decimal places, but eBUS Player may automatically round the value and display a different value.

5. Now the new camera's virtual pixel size is $3.45 \mu\text{m} \times 3.45 \mu\text{m}$, and the output image size is 1920×1200 .

Example 3

If you are using a GOX-20405 with SensorWidth/SensorHeight of 4512, and you want to scale the output image to 3000×3000 , set ImageScalingHorizontal and ImageScalingVertical to "0.6649" ($3000 \div 4512 = 0.6649$).



Decimation Mode

Related Setting Items: [ImageFormatControl](#)

Decimation mode performs 2X downsampling of the image horizontally, vertically, or both. This reduces the file size for processing or storage while maintaining the full field of view of the image. Please set DecimationHorizontal, DecimationVertical in [ImageFormatControl](#).

Notes:

- Refer to [Functions That Cannot Be Used Together](#) for usage restrictions.
- When using Decimation Mode, the [ROI Function \(Single ROI\)](#) function can be configurable but may not operate as expected.

Gradation Compression Mode

Related Setting Items: [ImageFormatControl](#)

This function compresses the bit depth of captured images to enable images containing a wide range of pixel values to be output as a narrower set of intensity gradations.

Notes:

- This function cannot be used when [SensorDigitizationBits](#) is set to 8Bits.
- When GradationCompressionMode is turned On, the [Pixel Format](#) is forced to be controlled as follows:

Mono models: Mono8

Color models - Bayer format: BayerRG8 (When ReverseX/Y is On, the flipped Bayer format is used).

In Gradation Compression Mode, the sensor first converts the analog signal into 10bits or 12bits digital signal (= A/D conversion), and then the A/D-converted signal exceeding the compression knee point (s) is compressed and the entire image is output as 8bits data. (Whether A/D conversion is performed at 10 or 12 bits is based on the [SensorDigitizationBits](#) setting.)

The apparent sensitivity of the uncompressed area below the knee point is x4 at 10bits and x16 at 12bits.

The maximum value of each dynamic range is 400% at 10bits and 1600% at 12bits, comparing to the 8bits output.

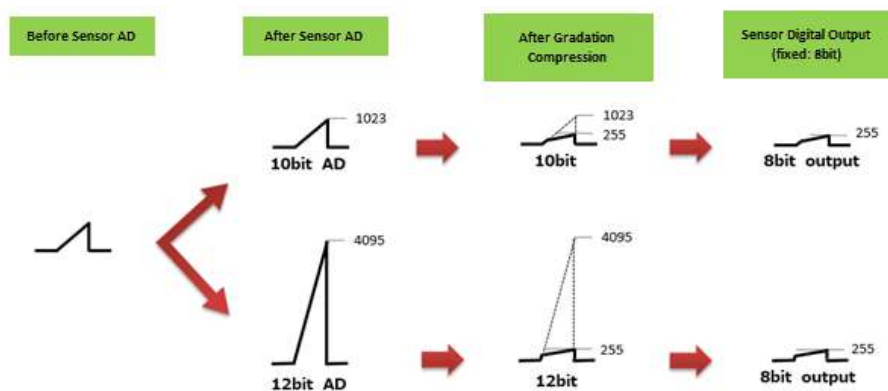

How to Configure

1. Set **GradationCompressionMode** to **On** to enable the function.
2. Select a value for **GradationCompression1stKneePoint** to indicate where to start applying compression on the intensity values coming from the sensor. The knee point is specified as a percentage of the maximum digital value of the 8-bit compressed output (255).
3. Select a value for **GradationCompression1stGain** in order to set the slope angle at the first knee point. Available values range from 0 dB (no compression) to -66 dB.
4. Use **GradationCompression2ndKneePoint** and **GradationCompression2ndGain** to define an additional compression segment.

Note: 2ndKneePoint must be specified with a value greater than 1stKneePoint. The maximum value is 200% when SensorDigitizationBits is set to 10Bits, and 800% when SensorDigitizationBits is set to 12Bits.

Examples

The following examples show how Gradation Compression knee points and gain can be calculated and applied.

SensorDigitizationBits = 10Bits

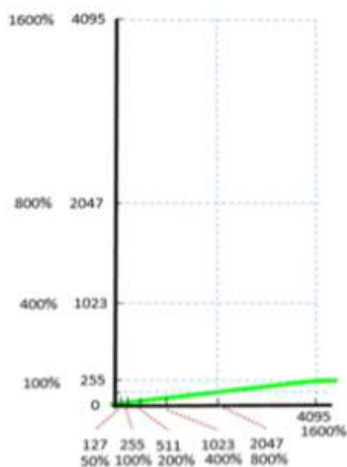

GradationCompressionMode = Off

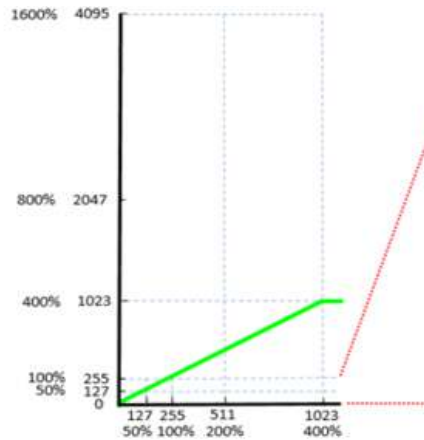

GradationCompressionMode = On
GradationCompression1stGain = 0dB
GradationCompression2ndGain = 0dB

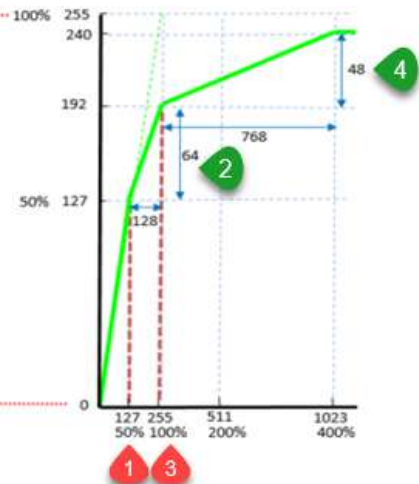

GradationCompressionMode = On
 1 GradationCompression1stKneePoint = 50%
 2 GradationCompression1stGain = - 6dB
 (64/128 = 1/2 = -6dB)
 3 GradationCompression2ndKneePoint = 100%
 4 GradationCompression2ndGain = - 24dB
 (48/768 = 1/16 = -24dB)

SensorDigitizationBits = 12Bits

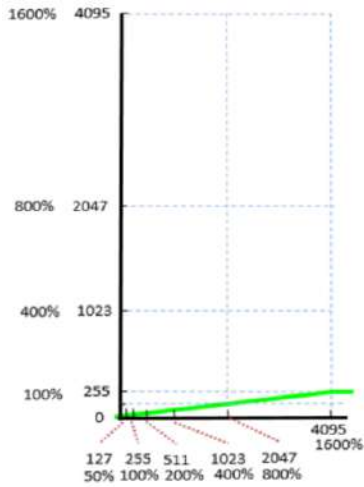

GradationCompressionMode = On

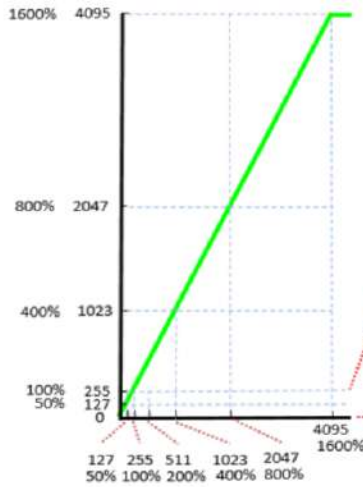

GradationCompressionMode = On
GradationCompression1stGain = 0dB
GradationCompression2ndGain = 0dB

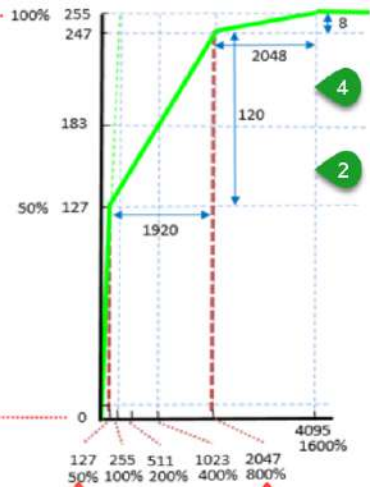

GradationCompressionMode = On
 1 GradationCompression1stKneePoint = 50%
 2 GradationCompression1stGain = -24dB
 (120/190 = 1/16 = -24dB)
 3 GradationCompression2ndKneePoint = 800%
 4 GradationCompression2ndGain = -48dB
 (8/2048 = 1/256 = -48dB)

Cautions:

- When VideoProcessBypassMode is set to **Off**, JAI cannot guarantee the configured knee point value because the GradationCompression1st(2nd)KneePoint value will not match the output signal's knee point level due to the effect of the digital gain value, which is performed during post-processing. In order to avoid this, set VideoProcessBypassMode = **On**.
- When VideoProcessBypassMode is set to **Off**, JAI cannot guarantee the white balance function's performance because the white balance function uses the digital gain during post-processing, and the output signal's knee point level between the RGB channels will not match. In order to avoid this, set VideoProcessBypassMode = **On**, and control the white balance on the Host side.

Overlay Mode

Related Setting Items: [ImageFormatControl](#)

Note: This function cannot be used with the [Sequencer Function](#).

■ OverlayMode = MultiRoiAreaMode

In this mode, you can check the readout area when using the [ROI Function \(Multi ROI\)](#). The area that is not readout is displayed with the brightness reduced to half. This makes it possible to set and adjust the readout area while checking the target area on the screen.

Notes:

- To set Overlay Mode to **MultiRoiAreaMode**, MultiRoiMode ([MultiROIControl](#)) must be set to **Off** in advance.
- In the following scenario, OverlayMode = MultiRoiMode will be disabled (you can still set to **ALCAreaMode** or **AWBAreaMode**): DecimationVertical/DecimationHorizontal = 2, ImageScalingMode = On, BinningHorizontal = 2, BinningVertical = 2, FD2x2BinningMode = On

■ OverlayMode = AWBAreaMode or ALCAreaMode

When Overlay Mode is set to **AWBAreaMode** or **ALCAreaMode**, you can check the photometry areas of WhiteBalance and ALC. In the non-target area as shown below, the brightness is reduced to half.

MultiRoiAreaMode



AWBAreaMode or ALCAreaMode

HighLeft	HighMidLeft	HighMidRight	HighRight
MidHighLeft	MidHighMidLeft	MidHighMidRight	MidHighRight
MidLowLeft	MidLowMidLeft	MidLowMidRight	MidLowRight
LowLeft	LowMidLeft	LowMidRight	LowRight

ROI Function (Single ROI)

Related Setting Items: [ImageFormatControl](#)

The ROI (region of interest) function allows you to output images by specifying the areas to scan. Specify the area to scan by specifying width, height, and horizontal/vertical offset values under ImageFormatControl.

You can increase the frame rate by specifying a lower height, as the number of lines scanned decreases. The setting ranges for the ROI function's readable area based on the Binning setting (BinningHorizontal, BinningVertical, FD2x2BinningMode) are as follows.

Notes:

- The [Binning Function](#) (Horizontal/Vertical Binning and FD2x2BinningMode) can only be used for monochrome camera models.
- When using this function with [Image Scaling Mode \(Xscale\)](#), first, set the Width, Height, OffsetX, and OffsetY settings, and then configure the Image Scaling Mode settings.
- When using Decimation Mode, the [ROI Function \(Single ROI\)](#) function can be configurable but may not operate as expected.
- Refer to [Functions That Cannot Be Used Together](#) for usage restrictions.

Width/OffsetX (Pixels)

Width OffsetX	Binning Mode	Binning OFF	Binning ON	*A,B = WidthMax		
					A	B
Width (pixels)	Horizontal Binning	96 to [(*A) - OffsetX], step 8	48 to [(*B) - OffsetX], step 4			
	FD2x2BinningMode					
Offset X (pixels)	Horizontal Binning	0 to [(*A) - Width], step 8	0 to [(*B) - Width], step 4			
	FD2x2BinningMode					

Height/OffsetY (Lines)

Height OffsetY	Binning Mode	Binning OFF	Binning ON	*C, D = HeightMax		
Height (lines)	Vertical Binning	8 to [(*C) - OffsetY], step 2	4 to [(*D) - OffsetY], step 1		C	D
	FD2x2BinningMode			GOX-5105MC-5GE	2064	1032
OffsetY (lines)	Vertical Binning	0 to [(*C) - Height], step 2	0 to [(*D) - Height], step 1	GOX-8105MC-5GE	2848	1424
	FD2x2BinningMode			GOX-12405MC-5GE	3008	1504
				GOX-16205MC-5GE	3040	1520
				GOX-20405MC-5GE	4512	2256
				GOX-24505MC-5GE	4608	2304

Single ROI - Example

Binning Off

[BinningHorizontal]: 1, [BinningVertical]: 1

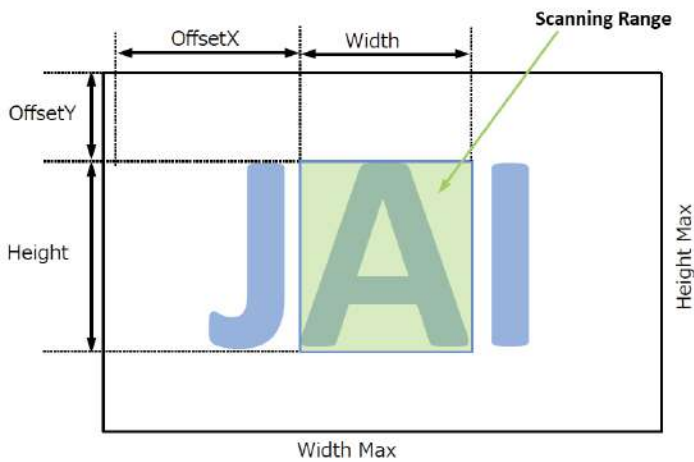

Binning On

[BinningHorizontal]: 2, [BinningVertical]: 2

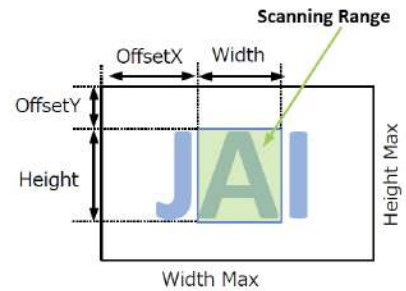

ROI Function (Multi ROI)

Related Setting Items: [MultiROIControl](#)

Notes:

- Refer to [Functions That Cannot Be Used Together](#) for usage restrictions.
- If this function is turned on while [Shading Correction](#) is set to On, Shading Correction will be forced to Off.

In Multi ROI mode, you can specify up to 64 scanning areas for a single-frame image. By skipping areas that are not specified as regions of interest when scanning a frame, the ROI function outputs the specified regions in a combined state. You can increase the frame rate due to the reduced scanning time for the combined areas. However, you cannot increase the frame rate by compressing in the horizontal direction.

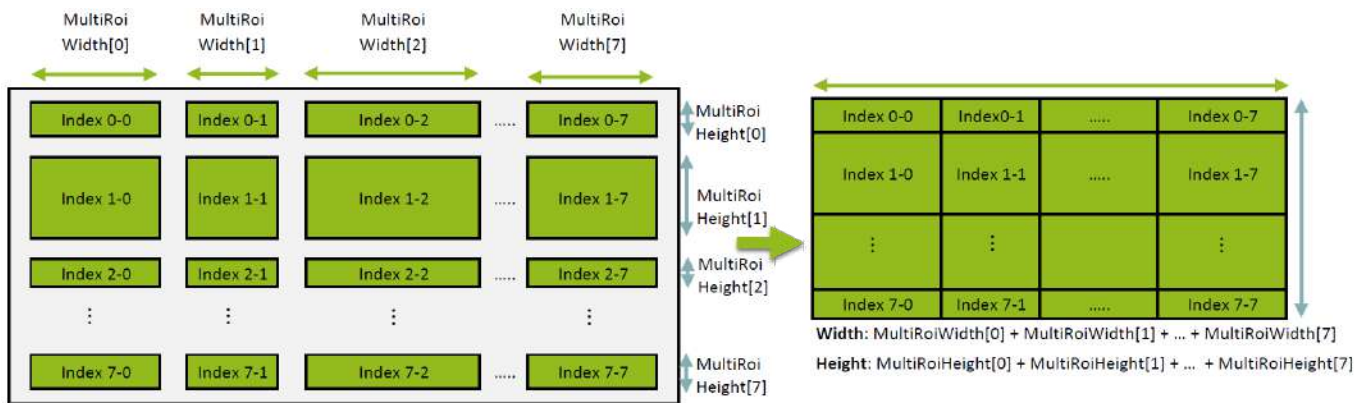

How to Configure

1. Set **MultiRoiMode (MultiROIControl)** to On.
2. Select from the eight indexes in `MultiRoiIndex` then set **MultiRoiWidth**, **MultiRoiHeight**, **MultiRoiOffsetX**, and **MultiRoiOffsetY**.
3. Set the maximum index number to be enabled to **MultiRoiVerticalEnableNumber** and **MultiRoiHorizontalEnableNumber**.

Caution: The specified areas cannot overlap. If the areas overlap, all indexes after the overlapping areas become unconfigurable.

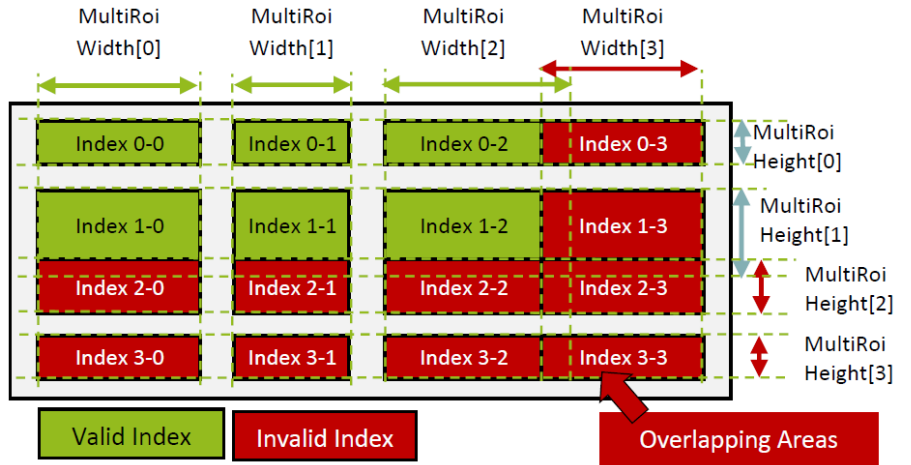

Notes:

- The frame rate can be increased in relation to the size of the area specified in the vertical direction, but not in relation to the horizontal direction.

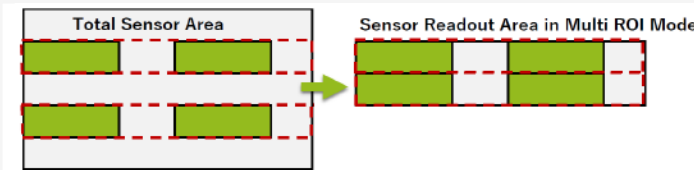

- In the horizontal direction, the configuration for the second and subsequent rows will be identical. In the vertical direction, the configuration for the second and subsequent columns will be identical.

Configuration Example

To use four areas as shown below, refer to the following.

1. Set MultiROIControl->**MultiRoiMode On**.
2. Select "0" in MultiRoiIndex. Set MultiRoiWidth, MultiRoiHeight, MultiRoiOffsetX and MultiRoiOffsetY.
3. Select "1" in MultiRoiIndex. Set MultiRoiWidth, MultiRoiHeight, MultiRoiOffsetX and MultiRoiOffsetY.
4. Set 2 to MultiRoiVerticalEnableNumber.
5. Set 2 to MultiRoiHorizontalEnableNumber.

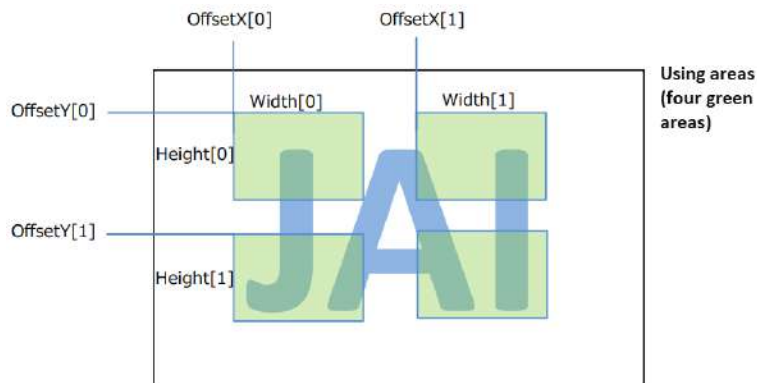

Output image

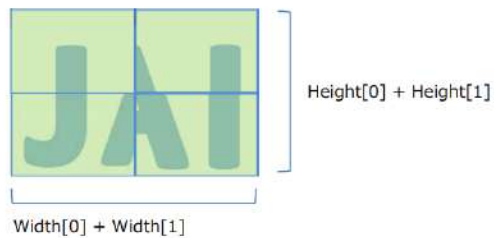

Color Space Conversion (ColorTransformationControl)

Related Setting Items: [ColorTransformationControl](#)

Note: This function is available only when the [Pixel Format](#) is set to **RGB8**, **RGB10V1Packed**, or **RGB10p32**.

This camera allows you to convert the standard color space (RGB) that is used to produce colors into other color spaces, including XYZ. Four color spaces are available: RGB(sRGB), RGB(AdobeRGB), RGB(UserCustom), XYZ. Specify the desired color space by configuring ColorTransformationMode and ColorTransformationRGBMode as follows.

ColorTransformation	ColorTransformationMode	ColorTransformationRGBMode
RGB (sRGB)	RGB	sRGB
RGB (AdobeRGB)	RGB	AdobeRGB
RGB (UserCustom)	RGB	UserCustom
XYZ	XYZ	Off
Default	RGB	Off

Note on RGB (UserCustom)

This allows you to use user-configured 3x3 conversion tables to perform color space conversion.

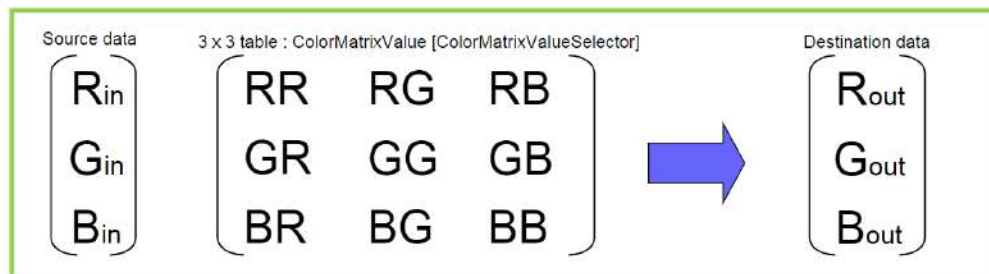

Caution: If you set the color space to XYZ, Control Tool will not display the images captured by the camera properly. To display them properly, XYZ-compatible image processing must be performed on the computer side.

Configuration 3x3 table

1. Select the item you want to configure in ColorMatrixValueSelector.
2. Configure the value in ColorMatrixValue.

3. ColorMatrixValue can be set to a value from -2 to +2.

See [ColorTransformationControl](#) for detailed information on the setting items.

Edge Enhancer, Color Enhancer

Related Setting Items: [ImagingControl](#)

This camera is equipped with an Edge Enhancer function for enhancing the contrast of lines or edges within images and a Color Enhancer function for enhancing specified colors.

Edge Enhancer Function

Note: On this camera, the Edge Enhancer function is only available for monochrome models.

The Edge Enhancer function is enabled when EdgeEnhancerEnable is set to On. Four enhancement levels are available: Low, Middle, High, and Strong.

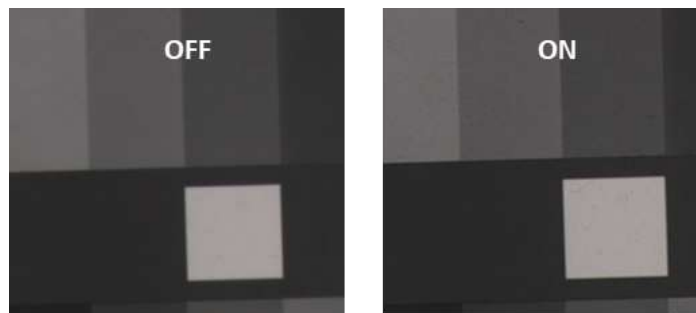

Color Enhancer Function

Note: This function is available only when the [Pixel Format](#) is set to **RGB8**, **RGB10V1Packed**, or **RGB10p32**.

The Color Enhancer function is enabled when ColorEnhancerEnable is set to On. Set a value from 0 to 1.0 (0.1 steps) for ColorEnhancerValue to configure the enhancement level: 0 = no enhancement, 1.0 = approx. x2 the color level of the original data.

Six colors can be specified in ColorEnhancerSelector: Red, Cyan, Green, Magenta, Blue, and Yellow.

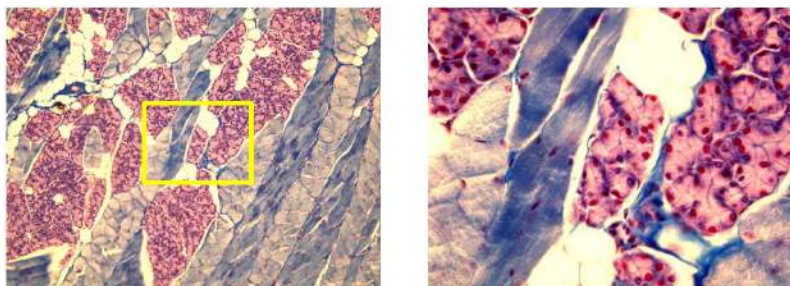

Sequencer Function

Related Setting Items: [SequencerControl](#)

The Sequencer function lets you define up to 32 index combinations of exposure time, gain, ROI, and other settings which can be stepped through each time a trigger is received. This is particularly useful for quickly capturing multiple exposures of objects under inspection to adjust for areas or components with significantly different levels of reflectance. You can specify the next index in the stepping sequence and the order in which indexes are executed. Multiple indexes can also be executed repeatedly.

Two operation modes (TriggerSequencer mode and CommandSequencer mode) are available for the Sequencer function.

Notes:

- Refer to [Functions That Cannot Be Used Together](#) for usage restrictions.
- Up to 32 indexes can be configured. For details on the items that can be set for each index, see [SequencerControl](#).

Cautions:

- If the values of [ImageFormatControl](#)'s Width and Height are smaller than SequencerControl's SequencerWidth and SequencerHeight, the image may not be output correctly.
- When using SequencerWidth / SequencerHeight, set the Width and Height to the default values in advance.

TriggerSequencer Mode

With this mode, the Sequencer Trigger “pattern” is predetermined by the user. The user defines up to 32 different “indexes.” Different camera settings can be configured for each index. The operation of this mode is controlled using the following five commands.

Caution: In TriggerSequencer mode, the TriggerOverlap function of the FrameStart trigger is disabled and the operation is always Off.

SequencerSetActive: This allows you to confirm the index number displayed on the next trigger reception.

SequencerSetStart: This configures the index number to execute at the start of TriggerSequencer mode.

SequencerFrameCount: This configures the number of frame acquisitions for the selected SequencerIndex.

SequencerReset: During TriggerSequencer mode operation, this switches the index number to be executed to that specified in SequencerSetStart.

SequencerRepetition: This parameter applies to TriggerSequencer patterns which include an index whose SequencerROINextIndex is set to 0 (OFF).

When the index whose SequencerROINextIndex is set to 0 (OFF) is finished executing, the value of Sequencer Repetition (range = 1~ 255) is decremented internally. If the result of the decrement is not zero, the TriggerSequencer pattern starts over from the index specified in SequencerSetStart. If the result of the decrement is zero, the status changes to Acquisition Stop and external triggers are not accepted.

Sample TriggerSequencer Mode Operation

User-Defined Indexes (Up to 32)

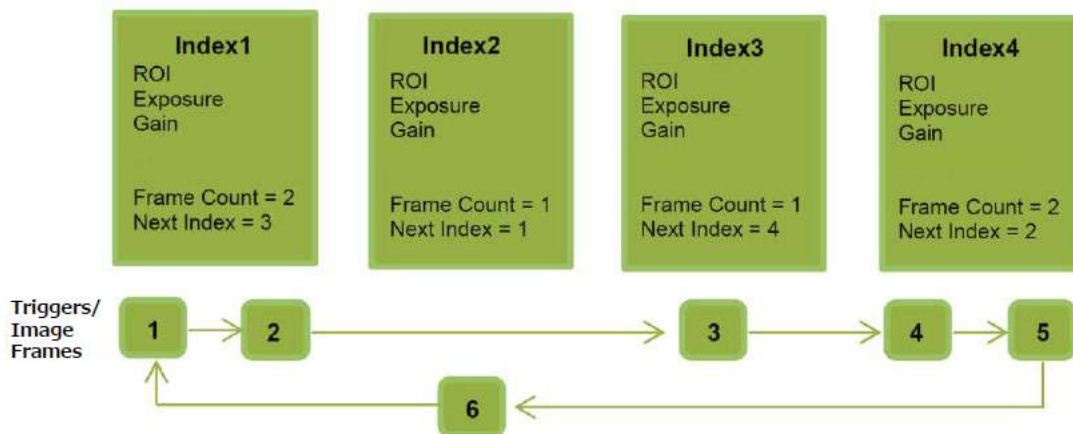

1. Specify "1" in SequencerSetStart, and start TriggerSequencer mode with index 1.
2. Based on the SequencerFrameCount setting (= 2), capture a 2-frame image with the first and second triggers.
3. For the next index, configure index 3 specified in SequencerSetNext, and capture an image with the number of frames (the number of triggers) specified in SequencerFrameCount (=1).
4. Proceed to sequence from index 4 to index 2 to index 1.

Note: In addition to repeating multiple conditions as in the above example, you can specify "0" (which indicates the end of TriggerSequencer mode) in SequencerSetNext of index 2, and specify the number of repetitions in SequencerRepetition.

CommandSequencer Mode

As with TriggerSequencer mode, you can define up to 32 indexes beforehand in this mode. Set SequencerCommandIndex to point to one of your preconfigured indexes. This index will be executed on each trigger, until it is changed to point to a different index, typically by your vision application.

In this way, Command Sequencer mode allows you to programmatically adjust your sequence in response to image analysis or input from other sensors.

Notes:

- The same index table will be executed for subsequent triggers unless the CommandSequencerIndex value is changed.
- SequencerFrameCount, SequencerSetNext and SequencerRepetition cannot be used in CommandSequencer mode.

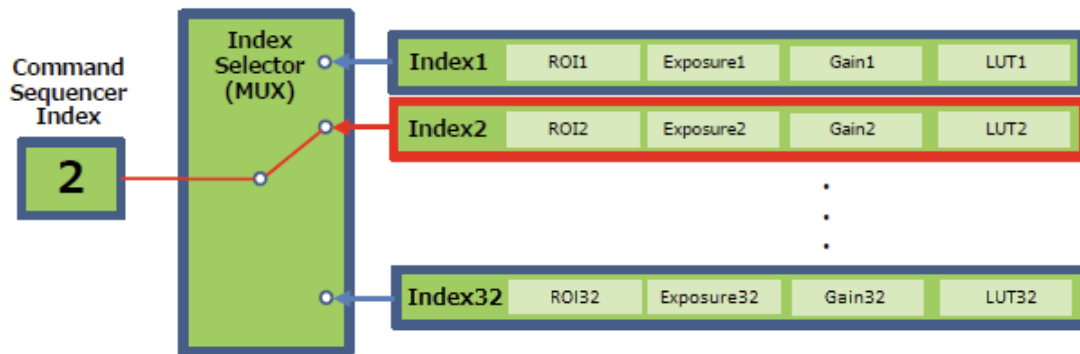

Pulse Generator

Related Setting Items: [PulseGenerator](#)

Technical Notes Tips for using the Pulse Generator

By using this function, any signal can be generated inside the camera.

The following is an example of signal generation.

Settings

- PulseGeneratorStartPoint = 2
- PulseGeneratorEndPoint = 6
- PulseGeneratorLength = 10
- PulseGeneratorPulseWidth = 4
- PulseGeneratorClearSyncMode = AsyncMode

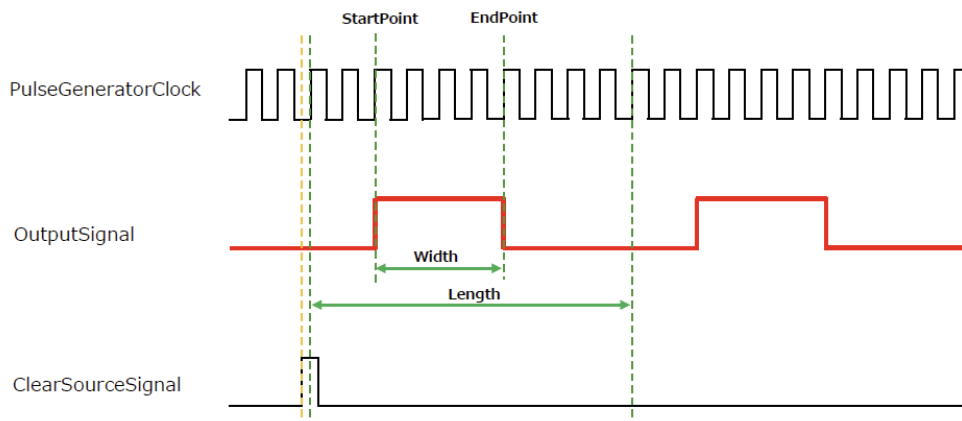

The table below shows the PulseGeneratorClearSource signals that can be set.

	Off	AcquisitionActive	FrameActive	ExposureActive	FVAL	PulseGenerator0	PulseGenerator1	PulseGenerator2	PulseGenerator3	UserOutput0	UserOutput1	UserOutput2	UserOutput3	Line5 Opt In1	NAND0 Out	NAND1 Out	Low	High	AcquisitionTriggerWait	FrameTriggerWait	
PulseGenerator0		✓	✓	✓	✓		✓	✓	✓	✓	✓	✓	✓	✓	✓	✓	✓	✓	✓	✓	✓
PulseGenerator1		✓	✓	✓	✓	✓		✓	✓	✓	✓	✓	✓	✓	✓	✓	✓	✓	✓	✓	✓
PulseGenerator2		✓	✓	✓	✓	✓	✓		✓	✓	✓	✓	✓	✓	✓	✓	✓	✓	✓	✓	✓
PulseGenerator3		✓	✓	✓	✓	✓	✓	✓		✓	✓	✓	✓	✓	✓	✓	✓	✓	✓	✓	✓

Counter and Timer Control Function

Related Setting Items: [CounterAndTimerControl](#)

Note: This camera supports only the counter function.

The counter function counts up change points in the camera's internal signals using the camera's internal counter and reads that information from the host side. This function is useful for verifying error conditions via the count value using internal camera operations.

Four counters are available on the camera; Counter0, Counter1, Counter2, and Counter3. The functions that can be counted are fixed for each counter.

- Counter0: Counts the number of FrameTrigger.
- Counter1: Counts the number of ExposureStart.
- Counter2: Counts the number of SensorReadOut.
- Counter3: Counts the number of FrameTransferEnd.

When a problem occurs in a system that includes this camera, comparing the values from multiple counters allows you to verify the extent of normal operability and can be useful when investigating the cause of the problem.

Counter Occurrence Diagram

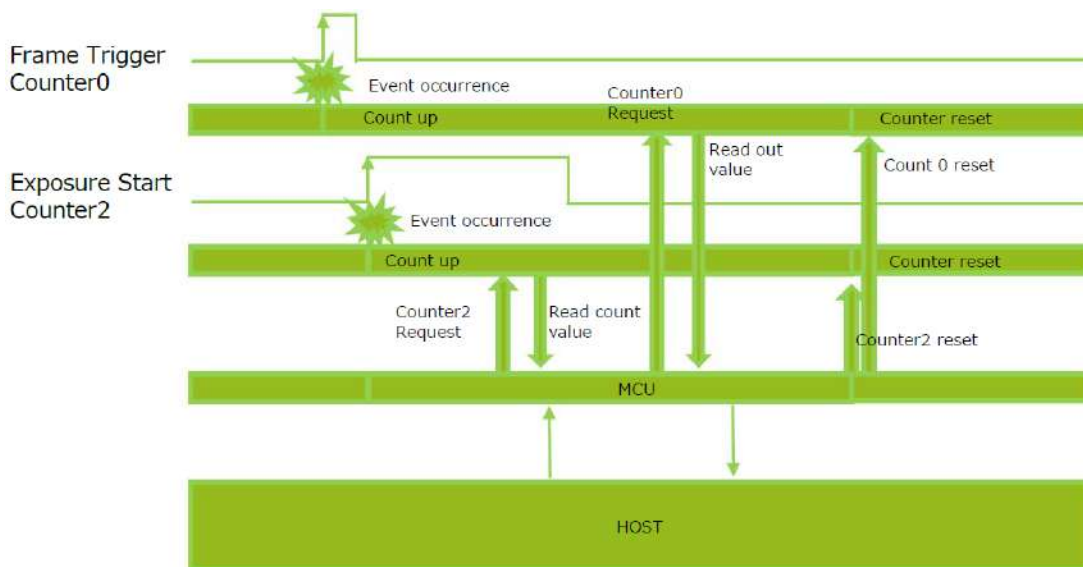

Note: You can reset a specific counter's count value by executing CounterReset[Counter0, Counter1, Counter2, Counter3].

Internal Camera Blocks

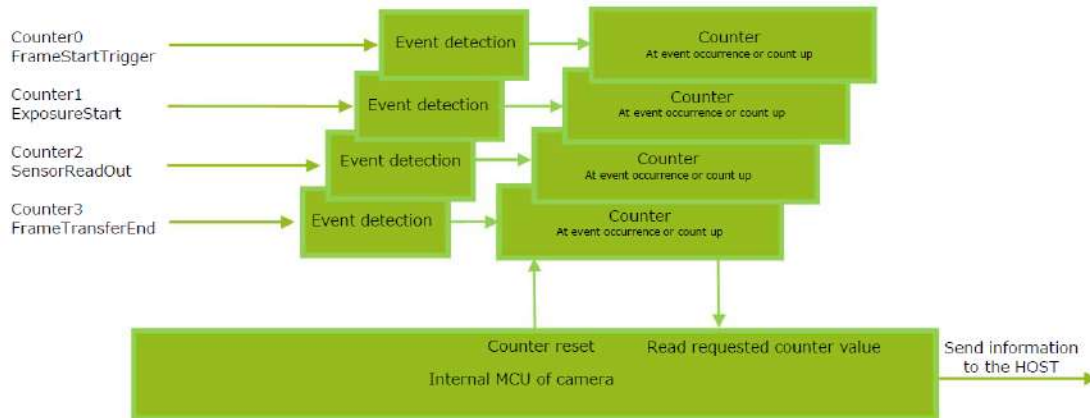

To Use the Counter Function

Configure the settings as follows.

Four counters are available. Specify a counter (Counter0 to Counter3), and configure the settings.

Item	Setting Value Selectable Range	Description
Counter 0 ~ 3	Counter 0 ~ 3	Select the counter.
CounterEventSource	Counter0: Off, Frame Trigger Counter1: Off, ExposureStart Counter2: Off, SensorReadOut Counter3: Off, FrameTransferEnd	Select the Counter Event signal for which to read the count value. When set to Off, the counter operation will stop (but will not be reset).
CounterEventActivation	When the Counter function is enabled: Counter0, Counter1, Counter2 = RisingEdge (Fixed) Counter3 = FallingEdge (Fixed)	Specify timing at which to count.

Action Control Function

Related Setting Items: [ActionControl](#)



Technical Notes

How to use GigE Vision Action Commands

The Action Control Function is a function that executes the pre-configured action when the camera receives action commands. Action commands can send both unicast and broadcast messages and give instructions for actions to multiple cameras simultaneously by broadcasting them. A camera that has this function can even give instructions for actions to different types of multiple cameras. Although this function includes jitter and delays, it is useful for controlling multiple cameras simultaneously.

When the [PTP \(Precision Time Protocol\)](#) function is turned on, Scheduled Action Command (Action Control function) becomes available, which allows you to send Action Commands to multiple cameras synchronized with PTP at the same time.

Actions are performed when the following three conditions are met.

1. ActionDeviceKey set to the camera and ActionDeviceKey in the action command match.
2. ActionGroupKey set to the camera and ActionGroupKey in the action command match.
3. ActionGroupMask set to the camera and GroupMask in the action command perform AND operation, and the result is not 0.

How to Configure

1. Specify ActionDeviceKey.
2. Then, specify two actions that can be configured on the camera.
 - a. Action1
 1. Select 1 in ActionSelector.
 2. Specify ActionGroupMask [ActionSelector].
 3. Specify ActionGroupKey [ActionSelector].
 - b. Action2
 1. Select 2 in ActionSelector.
 2. Specify ActionGroupMask [ActionSelector].
 3. Specify ActionGroupKey [ActionSelector].
3. Set triggers (AcquisitionStart, AcquisitionEnd, FrameStart, AcquisitionTransferStart) to Action1 and Action2.

Action Control Example

Assume that the following settings have been pre-configured on the camera.

- ActionDeviceKey : 0x00001001
- ActionGroupMask[1] : 0x00000011
- ActionGroupKey[1] : 0x00000001
- ActionGroupMask[2] : 0x00000111
- ActionGroupKey[2] : 0x00000002

When the camera receives action commands (ActionDeviceKey:0x00001001, ActionGroupMask:0x00000011, ActionGroupKey: 0x00000002), Action2 is executed.

When the camera receives action commands (ActionDeviceKey:0x00001001, ActionGroupMask:0x00000011, ActionGroupKey: 0x00000001), ActionDevice and ActionGroupKey [1] match. However, the result of AND operation performed by ActionGroupMask is 0. Therefore, in this case, neither Action1 nor Action2 is executed.

Event Control Function

Related Setting Items: [EventControl](#)

The Event Control function is a function that outputs a signal change point inside the camera as information indicative of an event occurrence (event message).

Flow from Detecting an Event to Sending an Event Message

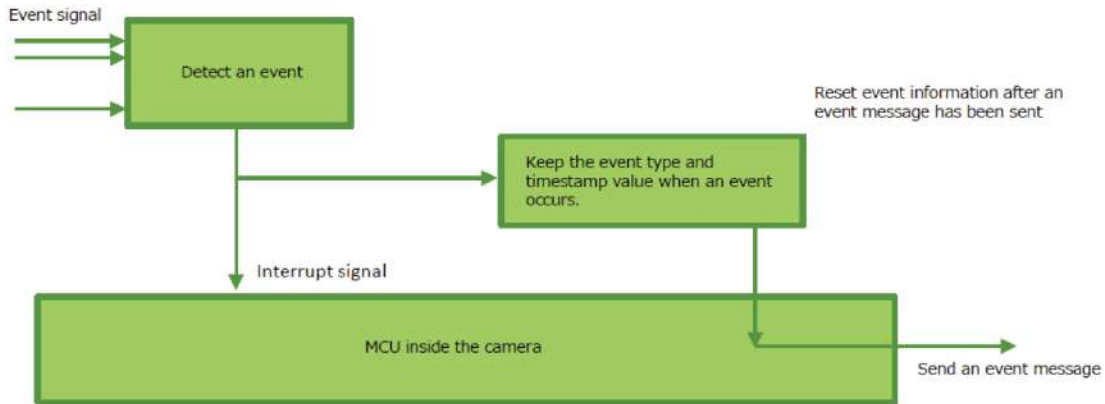

Events That Can Use the Event Control Function

Events that can use the Event Control function are as follows. You can specify whether or not to send an event message when an event occurs at each event.

- AcquisitionTrigger
- FrameStart
- FrameEnd
- ExposureStart
- ExposureEnd

Chunk Data Function

Related Setting Items: [ChunkDataControl](#)

The Chunk Data function adds camera configuration information to the image data that is output from the camera. In addition, when images are shot with a single camera in sequence under multiple setting conditions, you can search for images by their setting conditions.

■ Configuring Chunk Data

1. Set **ChunkModeActive** to **True**.

Caution: The Chunk Data function settings cannot be changed during image output. To change the settings, stop Acquisition.

PTP (Precision Time Protocol)

Related Setting Items: [TransportLayerControl](#)

The camera can work as the slave for Precision Time Protocol defined in IEEE 1588. When the IEEE 1588 master clock exists in the network where the camera is connected, this function synchronizes the camera to the time of the master clock.

- Transport to be used: Multicast UDP datagram (224.0.1.129); however, Delay Resp is a unicast UDP datagram.
- Destination port number:
 - 319 : Sync, Delay Req, Pdelay Req, Pdelay Resp
 - 320 : Announce, Follow Up, Delay Resp, Pdelay Resp, Management, Signaling
- Items for synchronization: Time synchronization is performed. Frequency tuning is not performed.
- PTP time data: 80 bit (elapsed time in 1 ns, with 00:00:00, January 1 1970 set as the origin)
- Timestamp (this camera): 64 bit* (PTP synchronization: LSB64bit* of PTP time data)
- Supported PTP messages: Announce message (receive only), Sync message (receive only), Follow Up message (receive only), Delay Req message (send only), Delay Resp message (receive only)

Cautions:

- The Timestamp Tick Frequency register value is fixed at 1,000,000,000 (1 GHz).
- When PTP synchronization is being performed, the Timestamp Reset function is disabled.
- Because GenICam treats the timestamp (64 bit) as a 64 bit signed integer, 63 bit is actually timestamp data without the sign bit.

How To Configure

1. Set **GevIEEE1588** ([TransportLayerControl](#)) to **True**.
2. After several statuses from Disable, when a Sync Message is received from the PTP server, **Slave** is Displayed in **GevIEEE1588 Status**.

Note: When the PTP function is **On**, you can use Scheduled Action Command ([ActionControl](#)), which allows you to send action commands to multiple cameras synchronized with PTP at the same time.

Non-Volatile Flash Memory

**Technical Notes**

Storing Data in On-Camera Flash Memory

The camera has non-volatile memory for users to store data. Refer to the technical note “Storing Data in On-Camera Flash Memory” for more information.





Note: JAI strongly recommends saving images to the PC or other storage location because the non-volatile flash memory may not have enough memory size to store large data.

Functions That Cannot Be Used Together

The table below shows functions that cannot be used with [ImageFormatControl](#), [MultiROIControl](#) and [SequencerControl](#) setting items.

Note: For functions that are not in this table, refer to the relevant function topic or setting item topic.

	Width, Height, OffsetX, OffsetY	FD2x2BinningMode	BinningHorizontal/Vertical	ImageScalingMode	DecimationHorizontal/Vertical	ReverseX/Y	GradationCompressionMode	ALCAreaMode/AWBAreaMod	OverlayMode = MultiRoiAreaMode	MultiRoiMode	SequencerMode
Width, Height, OffsetX, OffsetY (SingleROI)				1	2						
FD2x2BinningMode			3	3	3				3	3	3
BinningHorizontal/Vertical = 2		3		3	3				3	3	
ImageScalingMode	1	3	3		3				3	3	3
DecimationHorizontal/Vertical = 2	2	3	3	3					3	3	3
ReverseX/Y											3
GradationCompressionMode											3
OverlayMode = ALCAreaMode/AWBAreaMode											3
OverlayMode = MultiRoiAreaMode		3	3	3	3					2	3
MultiRoiMode		3	3	3	3				2		3
SequencerMode		3		3	3	3	3	3	3	3	

Empty	Can be used together
	Cannot be used together
	Configurable, but may not work as expected.
	When using Image Scaling Mode (Xscale) together with the ROI Function (Single ROI) , first, set the Width, Height, OffsetX, and OffsetY settings, and then configure the Image Scaling Mode settings.
	To set Overlay Mode to MultRoiAreaMode , MultiRoiMode (MultiROIControl) must be set to Off in advance.

Setting List

This camera complies with GenICam. Each setting item name conforms to GenICam SFNC (Standard Features Naming Convention). (There are some JAI-specific setting items).

Each setting item is an integer type (Integer), a real type (Float), an element enumeration type (Enumeration), a character string (String), a logical type (Boolean), and a category type (Category) or a command type (Command) for executing the function.

Beginner: For beginner users.

Expert: For users with deep knowledge of camera functions.

Guru: For advanced users who make settings, including advanced features that can cause the camera to malfunction if not set correctly.

Selector

A Selector is used to index which instance of the feature is accessed in situations where multiple instances of a feature exist.

Instance Example:

Each Line-related item (LineSource, LineInverter, etc.) has LineSelector-LineX instances, which can be set or referenced as an index.

Selectors are a feature of element enumeration type (Enumeration) or an integer type (Integer). However, unlike normal configuration items, it is only used to select the instance in the following configuration item.

It does not change the behavior of the camera by changing the value of the selector. Also, the selector may have only one selectable value. In this case, use the selector function only for information purposes. In this document, it is described as SelectedFeature[Selector] according to the description method of GenICam.

In the case of Line Selector with a specific I/O line selected, the description could be as follows.

```
LineSource[LineSelector-LineX] = High
LineInverter[LineSelector-LineX] = False
LineMode[LineSelector-LineX] = Input
LineFormat[LineSelector-LineX] = TTL
```

Generally, selectors only apply to a single category of features. (Example: TriggerSelector only applies to trigger related functions.)

Feature Properties

Note: Depending on the setting item, you may need to change visibility. Please switch visibility (Beginner / Expert / Guru) as necessary.

DeviceControl

Display/configure information related to the device.

DeviceControl Item	Setting Range	Default Value	Description
DeviceScanType	-	0:Areascan	Display the device scan type.
DeviceVendorName	-	"JAI Corporation"	Display the manufacturer name.
DeviceModelName	-	-	Display the model name.
DeviceManufacturerInfo	-	See the possibilities	Display the manufacturer information.
DeviceVersion	-	-	Display the device version.
DeviceFirmwareVersion	-	-	Display the firmware version.
DeviceFpgaVersion	-	-	Display the FPGA version.
DeviceSerialNumber	-	-	Display the device ID.
DeviceUserID	Any	-	Set the user ID (16bytes) for the camera.
DeviceSFNCVersionMajor	-	2	Display the SFNC Major version.
DeviceSFNCVersionMinor	-	5	Display the SFNC Minor version.
DeviceSFNCVersionSubMinor	-	0	Display the SFNC Sub-Minor version.
DeviceManifestEntrySelector	1	1	Display the valid XML file information.
DeviceManifestXML MajorVersion	0 ~ 32bit max	0	Display XML file's major version number.
DeviceManifestXML MinorVersion	0 ~ 32bit max	0	Display XML file's minor version number.
DeviceManifestXML SubMinorVersion	0 ~ 32bit max	1	Display XML file's sub-minor version number.
DeviceManifestSchema MajorVersion	0 ~ 32bit max	1	Display XML file's sub-major version number.
DeviceManifestSchema MinorVersion	0 ~ 32bit max	1	Display schema file's minor version number.
DeviceManifest PrimaryURL	-	-	Display the PrimaryURL.
DeviceManifest SecondaryURL	-	-	Display the SecondaryURL.
DeviceTLType	0:GigEVision (Fixed)	-	Transport Layer type of the device.

DeviceControl Item	Setting Range	Default Value	Description
DeviceTLVersionMajor	2 (Fixed)	-	Indicates the major version number of the device's Transport Layer.
DeviceTLVersionMinor	0 (Fixed)	-	Indicates the minor version number of the device's Transport Layer.
DeviceTLVersionSubMinor	1 (Fixed)	-	Indicates the sub-minor version number of the device's Transport Layer.
DeviceLinkSelector	0 (Fixed)	0	Select Link.
DeviceLinkSpeed	-	125000000 Bps	Displays the negotiated transmission rate.
DeviceLinkHeartbeatMode	0:Off 1:On	1:On	Enable/Disable Heartbeat mode.
DeviceLinkHeartbeatTimeout	500000~ 120000000	3000000	Configure the timeout value for Heartbeat (unit: μs). Step: 1000
DeviceStreamChannelCount	1 (Fixed)	-	Display the number of supported stream channels.
DeviceEventChannelCount	1 (Fixed)	-	Display the number of supported message channels.
DeviceCharacterSet	1: UTF8 (Fixed)	-	Display the character encoding.
DeviceReset	-	-	Reset the device. (After the camera receives this command, it returns an ACK response and executes the reset.)
DeviceRegistersEndianness	1:big-endian (Fixed)	-	Display the register's endianness.
DeviceTemperatureSelector	0: Mainboard 1: Sensor 2: FPGA	0: Mainboard	Select the area of the camera's interior for which to display the temperature sensor's reading.
DeviceTemperature	-55 ~ 125	0	Display the internal temperature (°C) of the device specified by DeviceTemperatureSelector.
Timestamp	0 ~ 64bit max	0	Display the timestamp value (ns). Resets to 0 when the signed maximum 64-bit value is exceeded.
TimestampReset	-	-	Forcibly sets the timestamp's count value to 0.
TimestampLatch	-	-	Sets the timestamp's count value to TimestampLatchValue.
TimestampLatchValue	0 ~ 64bit max	0	Maximum value Signed 64-bit max value.
UserDefinedValueSelector	0: Value1 1: Value2 2: Value3 3: Value4 4: Value5	0: Value1	Five 32bit data can be set and saved.
UserDefinedValue	-2147483648 ~ 2147483647	0	Selects one of the 32bit data (Value1 to Value5) set in UserDefinedValueSelector, and reads and sets the value in UserDefinedValue.

TransportLayerControl

Display information on transport layer control.

TransportLayerControl Item	Setting Range	Default Value	Description	
PayloadSize			Display the payload size. (Include ChunkData) (unit: bytes)	
GigEVision				
GevPhysicalLinkConfiguration	-	0:Single Link (Fixed)	Display the LinkConfiguration status.	
GevSupportedOptionSelector	-	0: SingleLink	Select the supported options for GigEVision.	
			Link Configuration	0: SingleLink
			nif Configuration	4:PAUSEFrameReception, 5:PAUSEFrameGeneration, 6:IPConfigurationLLA, 7:IPConfigurationDHCP, 8:IPConfigurationPersistentIP
			GVCP	11:MessageChannelSourceSocket, 12:CommandsConcatenation, 13:WriteMem, 14:PacketResend, 15:Event, 17:PendingAck, 18:IEEE1588, 19:Action, 21:ScheduledAction, 23:ExtendedStatusCodes, 24:ExtendedStatusCodesVersion2_0, 28:ManifestTable, 29:CCPApplicationSocket, 30:LinkSpeed, 31:HeartbeatDisable, 32:SerialNumber, 33:UserDefinedName
GVSP	9:StreamChannelSourceSocket, 10:StandardIDMode			
GevSupportedOption	-	-	Displays whether the function selected by GevSupportOptionSelector is supported or not.	
GevInterfaceSelector		0: (Fixed)		
GevMACAddress	-	-	Display the MAC address.	
GevPAUSEFrameReception	-	1: TRUE (Fixed)		
GevPAUSEFrameTransmission	-	1: TRUE (Fixed)		
GevCurrentIPConfiguration LLA	-	1: TRUE (Fixed)	Display whether the current IP configuration is calibrated by LLA (link-local address).	
GevCurrentIPConfiguration DHCP	0: False 1: True	1: TRUE	Select whether to set the IP configuration to DHCP.	
GevCurrentIPConfiguration PersistentIP	0: False 1: True	0: FALSE	Select whether to set the IP configuration to Persistent IP.	
GevCurrentIPAddress	-	-	Display the IP address.	
GevCurrentSubnetMask	-	-	Display the subnet.	

TransportLayerControl Item	Setting Range	Default Value	Description
GevCurrentDefaultGateway	-	-	Display the default gateway.
GevIPConfigurationStatus	-	2:DHCP	Display the current IP configuration status. Setting Range: 0:None, 1:PersistentIP, 2:DHCP, 3:LLA, 4:ForcelP
GevPersistentIPAddress	-	192.168.0.100	Set the persistent IP address.
GevPersistentSubnetMask	-	255.255.255.0	Set the persistent subnet mask.
GevPersistentDefaultGateway	-	0.0.0.0	Set the persistent default gateway.
NetworkThroughput SafetyMargin	10 - 100	92	For the configured LinkSpeed, set the limit to the bandwidth of the stream out of the camera (%). Caution: You can increase the frame rate by increasing this value. However, when set to more than 92 (default), abnormal images may be observed depending on the PC and its environment. If this happens, set the value to the default value (92).
GevIEEE1588 Related Topic: PTP (Precision Time Protocol)	0: False 1: True	0: FALSE	TRUE : Enables PTP FALSE: Disables PTP
GevIEEE1588ClockAccuracy	0 -20	19:Unknown	Indicates clock accuracy. Setting Range: 0:Within25ns, 1:Within100ns, 2:Within250ns, 3:Within1us, 4:Within2p5u, 5:Within10us, 6:Within25us, 7:Within100us, 8:Within250us, 9:Within1ms, 10:Within2p5ms, 11:Within10ms, 12:Within25ms, 13:Within100ms, 14:Within250ms, 15:Within1s, 16:Within10s, 17:GreaterThan10s, 18:AlternatePTPProfile, 19:Unknown, 20:Reserved
GevIEEE1588Status	-	-	Display the IEEE 1588 Status. 1:initializing, 2:faulty, 3:disabled, 4:listening, 5:preMaster, 6:master, 7:passive, 8:uncalibrated, 9:slave
GevGVCPExtendedStatus CodesSelector	0:Version1_1 1:Version2_0	0:Version1_1	Select the GevGVCPExtendedStatusCodes.
GevGVCPExtended StatusCodes	-	-	Enables the generation of extended status codes.
GevGVCPPendingAck Step 6: Adjust the Image Quality	0: Off 1: On	0: Off	Enables/disables the PENDING_ACK.
GevGVSPExtendedIDMode	0: Off 1: On	0: Off	Enables/disables Extended ID Mode.

TransportLayerControl Item	Setting Range	Default Value	Description
GevCCP	0~2	0:OpenAccess	Control access rights. 0:OpenAccess - Access rights have not been obtained by the application. 1:ExclusiveAccess - Once the application has made this setting, no other applications can control or reference the camera. 2:ControlAccess - Access rights have been obtained by the application. Other applications cannot control the camera, but can refer to it.
GevPrimaryApplicationSocket	-	-	Returns the UDP source port of the primary application.
GevPrimaryApplicationIPAddress	-	-	Returns the address of the primary application.
GevMCPHostPort	-	-	Controls the port to which the device must send messages. Setting this value to 0 closes the message channel.
GevMCDA	-	-	Controls the destination IP address for the message channel.
GevMCSP	-	-	This feature indicates the source port for the message channel.
GevStreamChannelSelector	0	0	Selects the stream channel to control.
GevSCCFGPacketResendDestination	0: False 1: True	0: FALSE	Enables the alternate IP destination for stream packets resent due to a packet resend request.
GevSCCFGAllInTransmission	0: False 1: True	0: FALSE	Enables the selected GVSP transmitter to use the single packet per data block All-in Transmission mode.
GevSCCFGUnconditionalStreaming	0: False 1: True	0: FALSE	Enables the camera to continue to stream, for this stream channel, if its control channel is closed or regardless of the reception of any ICMP messages (such as destination unreachable messages).
GevSCCFGExtendedChunkData	0: False 1: True	0: FALSE	Enables cameras to use the extended chunk data payload type for this stream channel.
GevSCPIInterfaceIndex	0	0 (Fixed)	Index of the logical link to use.
GevSCPHostPort	-	-	Controls the port of the selected channel to which a GVSP transmitter must send data stream or the port from which a GVSP receiver may receive a data stream. Setting this value to 0 closes the stream channel.
GevSCPSFireTestPacket	-	-	Sends a test packet. When this feature is set, the device will fire one test packet.
GevSCPSDoNotFragment	0: False 1: True	1: TRUE	The state of this feature is copied into the "do not fragment" bit of IP header of each stream packet. It can be used by the application to prevent IP fragmentation of packets on the stream channel.
GevSCPSPacketSize	1476~12036	1476	Specify the SCPS packet size (bytes).

TransportLayerControl Item	Setting Range	Default Value	Description
GevSCPD	-	0	Controls the delay (in GEV timestamp counter unit) to insert between each packet for this stream channel. (step 8) Min: 0 Max: The value depends on the PixelFormat, Width, GevGVSPExtendedIDMode, GevSCPSPacketSize, NetworkThroughputSafetyMargin settings.
GevSCDA	-	-	Controls the destination IP address of the selected stream channel to which a GVSP transmitter must send data stream or the destination IP address from which a GVSP receiver may receive data stream.
GevSCSP	-	-	Indicates the source port of the stream channel.
NetworkStatistics	-	-	Category containing statistics about the different modules of the GigE Vision transport layer.
oMACControlFunctionEntity	-	-	Category containing statistics related to the device's MAC control PAUSE function.
aPAUSEMACCtrlFrames Received	0~ 32bit max	0	Displays the number of Pause frames received.

ImageFormatControl

Configure image format settings.

Note: Refer to [Functions That Cannot Be Used Together](#) for usage restrictions.

Image Format Control Item	Setting Range	Default Value	Description
SensorWidth			Display the maximum image width. GOX-5105MC-5GE: 2472 GOX-8105MC-5GE: 2856 GOX-12405MC-5GE: 4128 GOX-16205MC-5GE: 5328 GOX-20405MC-5GE: 4512 GOX-24505MC-5GE: 5328
SensorHeight			Display the maximum image height. GOX-5105MC-5GE: 2064 GOX-8105MC-5GE: 2848 GOX-12405MC-5GE: 3008 GOX-16205MC-5GE: 3040 GOX-20405MC-5GE: 4512 GOX-24505MC-5GE: 4608
WidthMax			Display the maximum image width. GOX-5105MC-5GE: 2472 (1236) GOX-8105MC-5GE: 2856 (1428) GOX-12405MC-5GE: 4128 (2064) GOX-16205MC-5GE: 5328 (2664) GOX-20405MC-5GE: 4512 (2256) GOX-24505MC-5GE: 5328 (2664) Note: For monochrome models, when BinningHorizontal = 2 or FD2x2BinningMode = On, the value in parenthesis is applicable.
HeightMax			Display the maximum image height. GOX-5105MC-5GE: 2064 (1032) GOX-8105MC-5GE: 2848 (1424) GOX-12405MC-5GE: 3008 (1504) GOX-16205MC-5GE: 3040 (1520) GOX-20405MC-5GE: 4512 (2256) GOX-24505MC-5GE: 4608 (2304) Note: For monochrome models, when BinningVertical = 2 or FD2x2BinningMode = On, the value in parenthesis is applicable.

Image Format Control Item	Setting Range	Default Value	Description
Width Related Topic: ROI Function (Single ROI)	-	WidthMax value	Set the image width. Note: This setting is available only when ImageScalingMode=Off. Setting Range: 96 (48)*~ [WidthMax - OffsetX], Step 8(4)* *For monochrome models, when BinningHorizontal = 2 or FD2x2BinningMode = On, the value in parentheses is applicable.
Height Related Topic: ROI Function (Single ROI)	-	HeightMax value	Set the image height. Note: This setting is available only when ImageScalingMode=Off. Setting Range: 8 (4)*~ [HeightMax - OffsetY], Step 2(1)* *For monochrome models, when BinningVertical = 2 or FD2x2BinningMode = On, the value in parentheses is applicable.
OffsetX Related Topic: ROI Function (Single ROI)	-	0	Set the horizontal offset. Note: This setting is available only when ImageScalingMode=Off. Setting Range: 0~ [WidthMax - Width], Step 8(4)* *For monochrome models, when BinningHorizontal = 2 or FD2x2BinningMode = On, the value in parentheses is applicable.
OffsetY Related Topic: ROI Function (Single ROI)	-	0	Set the vertical offset. Note: This setting is available only when ImageScalingMode=Off. Setting Range: 0~ [Height - Height], Step 2(1)* *For monochrome models, when BinningVertical = 2 or FD2x2BinningMode = On, the value in parentheses is applicable.
FD2x2BinningMode Related Topic: Binning Function	0:Off 1:On	0:Off	Performs 2x2 analog binning (Sum processing). Monochrome models only.
BinningHorizontalMode Related Topic: Binning Function	0:Sum 1:Average	0:Sum	Set the processing method for horizontal binning. Monochrome models only.
BinningHorizontal	1~ 2	1	Set the number of pixels in the horizontal direction for which to perform binning. Monochrome models only.

Image Format Control Item	Setting Range	Default Value	Description
BinningVerticalMode Related Topic: Binning Function	0:Sum 1:Average	0:Sum	Set the processing method for vertical binning. Monochrome models only.
BinningVertical	1~2	1	Set the number of pixels in the vertical direction for which to perform binning. Monochrome models only.
ImageScalingMode Related Topic: Image Scaling Mode (Xscale)	0:Off 1:On	0:Off	Enables Image Scaling Mode.
ImageScalingSumMode	0:Off (Ave) 1:On (Sum)	0:Off (Ave)	Selects whether to use Sum or Average mode when ImageScalingMode is On.
ImageScalingHorizontal	0.0625~ 1	1	Specifies the horizontal scaling ratio in decimal units. For example, if you want to scale the image by 50% in the horizontal direction, specify "0.5".
ImageScalingHorizontalAbs	256~ 4096	-	Indicates the horizontal scaling ratio as an integer value (rounded down to the nearest whole number). The formula is: ImageScalingHorizontal X 4096.
ImageScalingVertical	0.0625~ 1	1	Specifies the vertical scaling ratio in decimal units. For example, if you want to scale the image by 50% in the vertical direction, specify "0.5".
ImageScalingVerticalAbs	256~ 4096	-	Indicates the vertical scaling ratio as an integer value (rounded down to the nearest whole number). The formula is: ImageScalingVertical X 4096.
ImageScalingBaseAbs	-	4096 (Fixed)	
DecimationHorizontalMode	-	0: Discard (Fixed)	Set Decimation Horizontal mode.
DecimationHorizontal Related Topic: Decimation Mode	-	1: None	If set to 2, Pixels(50%) are thinned out horizontally. 1: None 2: Pixels are thinned out horizontally
DecimationVerticalMode	-	0: Discard (Fixed)	Set Decimation Vertical mode.
DecimationVertical Related Topic: Decimation Mode	-	1: None	If set to 2, Pixels(50%) are thinned out vertically. 1: None 2: Pixels are thinned out vertically.

Image Format Control Item	Setting Range	Default Value	Description
ReverseX Related Topic: Image Flip Function	0~ 1	0	Reverse pixels horizontally.
ReverseY Related Topic: Image Flip Function	0~ 1	0	Reverse pixels vertically.
SensorDigitizationBits Related Topic: SensorDigitizationBits	8: 8 Bits 10: 10 Bits 12: 12 Bits	10: 10 Bits	Select the sensor output bits.

Image Format Control Item	Setting Range	Default Value	Description
<p>PixelFormat</p> <p>Related Topic: Pixel Format</p>	-	<p>BayerRG8</p> <p>Mono8</p>	<p>Set the pixel format.</p> <p>Color Models</p> <p>0x01080009: BayerRG8 (Default)</p> <p>0x0110000D: BayerRG10</p> <p>0x010C0027: BayerRG10Packed</p> <p>0x01100011: BayerRG12</p> <p>0x010C002B: BayerRG12Packed</p> <p>0x01080008: BayerGR8*</p> <p>0x0110000C: BayerGR10*</p> <p>0x010C0026: BayerGR10Packed*</p> <p>0x01100010: BayerGR12*</p> <p>0x010C002A: BayerGR12Packed*</p> <p>0x0108000A: BayerGB8*</p> <p>0x0110000E: BayerGB10*</p> <p>0x10C0028: BayerGB10Packed*</p> <p>0x01100012: BayerGB12*</p> <p>0x010C002C: BayerGB12Packed*</p> <p>0x0108000B: BayerBG8*</p> <p>0x0110000F: BayerBG10*</p> <p>0x010C0029: BayerBG10Packed*</p> <p>0x01100013: BayerBG12*</p> <p>0x010C002D: BayerBG12Packed*</p> <p>0x02180014: RGB8</p> <p>0x0220001C: RGB10V1Packed</p> <p>0x0220001D: RGB10p32</p> <p>Note: *When using the Image Flip Function</p> <p>Monochrome Models</p> <p>0x01080001: Mono8 (Default)</p> <p>0x01100003: Mono10</p> <p>0x010C0004: Mono10Packed</p> <p>0x01100005: Mono12</p> <p>0x010C0006: Mono12Packed</p>
<p>GradationCompression Mode</p> <p>Related Topic: Gradation Compression Mode</p>	<p>0: Off</p> <p>1: On</p>	<p>0: Off</p>	<p>Enables the sensor's gradation compression function.</p>

Image Format Control Item	Setting Range	Default Value	Description
GradationCompression1stKneePoint	-	50	Set the first knee point of the sensor's gradation compression function in percentage. Setting Range (%): 0, 6.25, 12.5, 25, 50, 100 Max Value: 0 or the GradationCompression2ndKneePoint value, whichever is smaller.
GradationCompression1stGain	-	0	Set the first knee compression rate for the sensor's gradation compression function in dB. Setting Range (dB): 0, -6, -12, -18, -24, -30, -36, -42, -48, -54, -60, -66
GradationCompression2ndKneePoint	-	100	Set the second knee point of the sensor's gradation compression function in percentage. Setting Range (%): 6.25, 12.5, 25, 50, 100, 200, 400, 800 Min Value: GradationCompression1stKneePoint. However, when GradationCompression1stKneePoint is set to 0, Min = 6.25
GradationCompression2ndGain	-	0	Set the second knee compression rate for the sensor's gradation compression function in dB. Setting Range (dB): 0, -6, -12, -18, -24, -30, -36, -42, -48, -54, -60, -66
TestPattern	-	0: Off	Select the test image. 0: Off (Default) 1: GreyHorizontalRamp 4: HorizontalColorBar (Color models only)
OverlayMode	-	0: Off	You can check the target area by reducing the brightness of the non-target area to 50%. 0: Off (Default) 1: MultiRoiAreaMode - Check the active area on MultiROI. 2: ALCAreaMode - Check the photometry area on ALC. 3: AWBAreaMode - Check the photometry area on AWB.
<p>Related Topic: Overlay Mode</p>			

MultiROIControl

Configure settings for Multi ROI.

Related Topic: [ROI Function \(Multi ROI\)](#)

Note: Refer to [Functions That Cannot Be Used Together](#) for usage restrictions.

Multi ROI Control Item	Setting Range	Default Value	Description
MultiRoiMode	0:Off 1:On	0	Enable/disable Multi Roi.
MultiRoiIndex	0~7	0	Select the index for the Multi Roi mode.
MultiRoiWidth	-	-	Set the width for the selected Multi Roi index. Setting Range: 96~ [WidthMax - MultiRoiOffsetX], Step 8 Default GOX-5105MC-5GE: 304 GOX-8105MC-5GE: 352 GOX-12405MC-5GE: 512 GOX-16205MC-5GE: 664 GOX-20405MC-5GE: 560 GOX-24505MC-5GE: 664
MultiRoiHeight	-	-	Set the height for the selected Multi Roi index. Setting Range: 8~ [HeightMax - MultiRoiOffsetY], Step 2 Default GOX-5105MC-5GE: 258 GOX-8105MC-5GE: 356 GOX-12405MC-5GE: 376 GOX-16205MC-5GE: 380 GOX-20405MC-5GE: 564 GOX-24505MC-5GE: 576
MultiRoiOffsetX	-	-	Set the horizontal offset for the selected Multi Roi index. Min: The minimum value of the range where each Index does not overlap. Max: The maximum value of the range where each Index does not overlap. Step: 8 Default: (Index number - 1) x MultiRoiWidth

Multi ROI Control Item	Setting Range	Default Value	Description
MultiRoiOffsetY	-	-	Set the vertical offset for the selected Multi Roi index. Min: The minimum value of the range where each Index does not overlap. Max: The maximum value of the range where each Index does not overlap. Step: 2 Default: (Index number - 1) x MultiRoiHeight
MultiRoiHorizontal EnableNumber	1~8	1	Set the maximum number of valid horizontal index numbers.
MultiRoiVertical EnableNumber	1~8	1	Set the maximum number of valid vertical index numbers.

AcquisitionControl

Configure image capture settings.

Acquisition Control Item	Setting Range	Default Value	Description
AcquisitionMode	0:SingleFrame 1:MultiFrame 2:Continuous	2:Continuous	Select the image capture mode.
	Related Topic: Acquisition Control		
AcquisitionStart	-	-	Start image capture.
AcquisitionStop	-	-	Stop image capture.
AcquisitionFrameCount	1 ~ 65535	1	In MultiFrame mode, set the number of frames to capture.
AcquisitionFrameRate	0.125 ~	-	<p>Display the frame rate as a frequency (unit: Hz). The maximum value varies depending on the Width, Height, PixelFormat, SensorDigitizationBits, Binning(Horizontal/Vertical), FD2x2BinningMode, ImageScalingMode, Decimation (Horizontal/Vertical), ChunkModeActive, GevSCSPacketSize, GevSCPD, NetworkThroughputSafetyMargin settings.</p> <p>Default</p> <p>GOX-5105MC-5GE: 98 fps GOX-8105MC-5GE: 62 fps GOX-12405MC-5GE: 41 fps GOX-16205MC-5GE: 32 fps GOX-20405MC-5GE: 25 fps GOX-24505MC-5GE: 21 fps</p> <p>Notes:</p> <ul style="list-style-type: none"> The fastest FPS value when set to: SensorDigitizationBits = 10bit, PixelFormat = 8bit., NetworkThroughputSafetyMargin = 92, PacketSize = 1476 Byte, ExtendedIDMode = Off. See Features for the frame rates when PacketSize is set to 12036.
	Related Topic: Changing the Frame Rate		
TriggerSelector	0:AcquisitionStart 1:AcquisitionEnd 2:FrameStart 3:Acquisition TransferStart	0:AcquisitionStart	Select the trigger operation.
	Related Topic: Trigger Control		
TriggerMode	0:Off 1:On	0:Off	Select the trigger mode.
TriggerSoftware	-	-	Execute a software trigger.

Acquisition Control Item	Setting Range	Default Value	Description
TriggerSource	-	24: Line5 Opt In	Select the trigger signal source. 7-10: PulseGenerator0-3 11-14: UserOutput0 -3 15-18: Action0-3 19:Software 24: Line5 Opt In 36: Nand0 Out 37: Nand1 Out
TriggerActivation	1:Rising Edge 2:Falling Edge 3:Level High 4:Level Low	1:Rising Edge	Select the polarity of the trigger signal (i.e., location of signal at which trigger is applied).
TriggerOverlap	0: Off (fixed) 1: ReadOut	-	Select the trigger overlap operation. TriggerSelector(AcquisitionStart/AcquisitionEnd/AcquisitionTransferStart) = 0:Off (Fixed) TriggerSelector(FrameStart) = 1: ReadOut
TriggerDelay	0 - 500000	0	Set the time of exposure start from trigger input. (unit: μ s)
ExposureMode	0: Off 1: Timed 2: TriggerWidth	1: Timed	Select the exposure mode.
ExposureTime (us)	-	-	Set the exposure time (us). Note: The actual exposure time will consist of the image sensor's offset duration (2.45us) added to the ExposureTime setting. Min: 1 Max: (1/AcquisitionFrameRateMax) - Next trigger prohibited time. Default: GOX-5105MC-5GE: TBD GOX-8105MC-5GE:TBD GOX-12405MC-5GE:TBD GOX-16205MC-5GE: TBD GOX-20405MC-5GE: TBD GOX-24505MC-5GE: TBD
ExposureAuto	0: Off 1:Once 2:Continuous	0: Off	Set whether to enable auto exposure. When set to Once, the automatic adjustment will be performed only once, and then automatically switched to Off.
ExposureModeOption	0: Off 1: RCT	0: Off	Enables RCT mode. Related Topic: RCT Mode

DigitalIOControl

Configure settings for digital input/output.

Related Topic: [GPIO \(Digital Input/Output Settings\)](#)

Digital IO Control Item	Setting Range	Default Value	Description
LineSelector	-	21: Line2 Opt Out1	Select the input/output to configure. 21: Line2 Opt Out1 24: Line5 Opt In1 53: Nand0 In1 54: Nand0 In2 55: Nand1 In1 56: Nand1 In2 63: TimestampReset
LineMode	-	-	Display the input/output status (whether it is input or output). 0: Input (LineSelector=24,53,54,55,56) 1: Output (LineSelector=21) 2: InternalConnection (LineSelector=63)
LineInverter	0: False 1: True	0: False	Enable/disable polarity inversion for the selected input signal or output signal. Note: LineSelector=24,63 are fixed to "0".
LineStatus	0: False 1: True	0: False	Display the status of the input signal or output signal (True: High, False: Low).

Digital IO Control Item	Setting Range	Default Value	Description
LineSource	-	-	<p>Select the line source signal for the item selected in LineSelector.</p> <p>0: Off (Only when LineSelector is set to TimestampReset) 1: AcquisitionActive 2: FrameActive 4: ExposureActive 5: FVAL 7-10: PulseGenerator0-3 11-14: UserOutput0-3 15-18: Action0-3 (only when LineSelector=TimestampReset) 24: Line5 Opt In1 36: Nand0 Out 37: Nand1 Out 40: - (Not selectable for Output and NAND In) 41: Low 42: High 43: AcquisitionTriggerWait 44: FrameTriggerWait</p> <p>※LineSelector=24 is fixed to "-".</p> <p>Default LineSelector=TimestampReset: Off(0) LineSelector=Other than TimestampReset: Line5 Opt In1 (24)</p>
LineFormat	-	-	<p>Display the signal format.</p> <p>2: TTL 5: OptoCoupled 7: Internal Signal</p> <p>Default LineSelector=21,24: OptoCoupled LineSelector=53,54,55,56,63: Internal Signal</p>
LineStatusAll	-	-	<p>Display the input/output signal status. The state is shown with 16 bits. Bit assignments are as follows.</p> <p>bit0: Unused (Fixed to 0) bit1: Line2 bit2 - 3: Unused (Fixed to 0) bit4: Line5 bit5 - 11: Unused (Fixed to 0) bit12: Nand0 In1 bit13: Nand0 In2 bit14: Nand1 In1 bit15: Nand1 In2</p>
OptInFilter (ns)	0~ 40000000	0	<p>Remove noise from the OptIn input signal of Digital I/O. Step: 100</p> <p>Setting Range: 0~ 40ms</p>

Digital IO Control Item	Setting Range	Default Value	Description
UserOutput Selector	-	0: User Output 0	Set the UserOutput signal. 0: User Output 0 1: User Output 1 2: User Output 2 3: User Output 3
UserOutput Value	0: False 1: True	0: False	Set the value for the UserOutput selected in UserOutputSelector.

PulseGenerator

Configure pulse generator settings.

Related Topic: [Pulse Generator](#)

Pulse Generator Item	Setting Range	Default Value	Description
ClockPreScaler	1 ~ 4096	297	Set the division value for the prescaler (12 bit) using PixelClock as the base clock.
PulseGeneratorClock (MHz)	-	0.25	Set the clock used for the pulse generator. This value is calculated using the [ClockPreScaler] value as a base. PulseGeneratorClock = SrcFreq / ClockPreScaler SrcFreq:74.25
PulseGeneratorSelector	0:PulseGenerator0 1:PulseGenerator1 2:PulseGenerator2 3:PulseGenerator3	0:PulseGenerator0	Select the pulse generator.
PulseGeneratorLength	1 ~ 1048575	25000	Set the maximum count-up value as a clock count.
PulseGeneratorLengthMs (ms)	-	100	Set the maximum count-up value in milliseconds. This value is calculated using the PulseGeneratorLength value as a base. The setting range varies depending on the ClockPreScaler value. PulseGeneratorLengthMs = 1/PulseGeneratorClock * PulseGeneratorLength
PulseGeneratorFrequency (Hz)	-	10	Set the maximum count-up value as a frequency. This value is calculated using the PulseGeneratorLength value as a base. PulseGeneratorFrequency = 1sec / PulseGeneratorLengthMs
PulseGeneratorStartPoint	0 ~ 1048575	0	Set the start point of the High interval as a clock count. When the counter reaches this value, the output will be 1.
PulseGeneratorStartPointMs (ms)	-	0	Set the start point of the High interval in milliseconds. When the counter reaches this value, the output will be 1. The setting range varies depending on the ClockPreScaler value. PulseGeneratorStartPointMs = 1/PulseGeneratorClock * PulseGeneratorStartPoint
PulseGeneratorEndPoint	1 ~ 1048575	12500	Set the start point of the Low interval as a clock count. When the counter reaches this value, the output will be 0.

Pulse Generator Item	Setting Range	Default Value	Description
PulseGeneratorEndPointMs (ms)	-	50	Set the start point of the Low interval in milliseconds. When the counter reaches this value, the output will be 0. The setting range varies depending on the ClockPreScaler value. PulseGeneratorEndPointMs = 1/PulseGeneratorClock * PulseGeneratorEndPoint
PulseGeneratorPulseWidth (ms)	-	50	Display the High interval width of the pulse in milliseconds. The duration between the Start Point and End Point is calculated. The setting range varies depending on the ClockPreScaler value. PulseGeneratorPulseWidth = 1/PulseGeneratorClock * (PulseGeneratorEndPoint - PulseGeneratorStartPoint)
PulseGeneratorRepeat Count	0~255	0	Set the repeat count for the counter. When this is set to 0, a free counter is enabled with no repeat limit.
PulseGeneratorClear Activation	0: Off 1: Rising Edge 2: Falling Edge 3: Level High 4: Level Low	0: Off	Set the clear signal condition for the count clear input of the pulse generator.
PulseGeneratorClear Source	-	24: Line5 Opt In1	Select the count clear input signal source. 1: AcquisitionActive 2: FrameActive 4: ExposureActive 5: FVAL 7-10: PulseGenerator0-3(*) 11-14: UserOutput0-3 24: Line5 Opt In1 36: Nand0 Out 37: Nand1 Out 43: AcquisitionTriggerWait 44: FrameTriggerWait Note: (*)Disabled if the PulseGenerator is selected in PUIseGeneratorSelector.
PulseGeneratorClear SyncMode	0:Async Mode 1:Sync Mode	0:Async Mode	Select the sync mode for the count clear input signal.

AnalogControl

Configure the analog control settings.

Analog Control Item	Setting Range	Default Value	Description
GainSelector	0: Analog All 1: Digital Red 3: Digital Blue	0: Analog All	Select the gain to configure. Note: DigitalRed and DigitalBlue are available only for color models.
Related Topic: Gain Control			
Gain	-	1	Set the gain value for the gain setting selected in GainSelector. Note: DigitalRed and DigitalBlue are available only for color models. Unit: Magnification AnalogAll: Min=1.0, Max=126.0, Step= 0.1dB DigitalRed/DigitalBlue: Min=0.447, Max=5.624, Step=0.000122 (Color model only)
GainAuto	0: Off 1: Once 2: Continuous	0: Off	Enable/disable gain auto adjustment. Once automatically changes to Off when the signal level converges once.
BlackLevelSelector	0: All 1: Red 3: Blue	0: All	Select the black level to configure. Note: DigitalRed and DigitalBlue are available only for color models.
BlackLevel	-	0	Set the black level value. All: Min=-133, Max=255 Red: Min=-64, Max=64 Blue: Min=-64, Max=64 Note: Red and Blue are available only for color models.
BalanceWhiteAuto	-	0: Off	Enable/disable auto white balance. When set to Once, the automatic adjustment will be performed only once, and then automatically switched to Off. Note: Color models only. 0: Off 1: Once 2: Continuous 5: Preset 3200K 6: Preset 5000K 7: Preset 6500K 8: Preset 7500K
Related Topic: White Balance			

Analog Control Item	Setting Range	Default Value	Description
AWBAreaSelector	-	0: Low Right	<p>Select the area for which to configure AWBAreaEnable.</p> <p>Note: Color models only.</p> <p>0: Low Right 1: Low Mid-Right 2: Low Mid-Left 3: Low Left 4: Mid-Low Right 5: Mid-Low Mid-Right 6: Mid-Low Mid-Left 7: Mid-Low Left 8: Mid-High Right 9: Mid-High Mid-Right 10: Mid-High Mid-Left 11: Mid-High Left 12: High Right 13: High Mid-Right 14: High Mid-Left 15: High Left</p>
AWBAreaEnable	0: False 1: True	1: True	Enable/disable the photometry area selected in AWBAreaSelector.
AWBAreaEnableAll	0: False 1: True	1: True	<p>True: Operate BalanceWhiteAuto with all areas designated as photometry areas, regardless of the individual enabled/disabled photometry area states configured in AWBAreaSelector.</p> <p>False: Operate BalanceWhiteAuto according to the individual enabled/disabled photometry area states configured in AWBAreaSelector.</p>
AWBControlSpeed	1~8	4	Set the response speed for BalanceWhiteAuto. (8 is the fastest)
BalanceWhiteAuto Result	-	0: Idle	<p>Display the results of BalanceWhiteAuto.</p> <p>Note: Color models only.</p> <p>0: Idle 1: Processing 2: Converging 3: Succeeded 4: Error1 - G image was too bright 5: Error2 - G image was too dark 6: Error3 - Timeout 7: Error4 - could not processing 8: Error5 - R or B image was out of range</p>

Analog Control Item	Setting Range	Default Value	Description
Gamma	0.45~1	0.45	Set the gamma value. Setting Range: 0.45, 0.50, 0.55, 0.60, 0.65, 0.75, 0.80, 0.90, 1.00
LUTMode	0: Off 1: Gamma 2: LUT	0:Off	Select the LUT mode.

LUTControl

Configure LUT settings.

Related Topic: [LUT \(Lookup Table\)](#)

LUT Control Item	Setting Range	Default Value	Description
LUTSelector	0: Red 1: Green 2: Blue	0: Red	Select the LUT channel to control. Note: Color models only.
LUTIndex	0~ 256	0	Set the LUT index table number.
LUTValue	0~ 4095	Gamma= 1.0	Set the LUT value.

AutoLevelControl

Configure AutoLevelControl.

Related Topic: [ALC \(Automatic Level Control\) Function](#)

Auto Level Control Item	Setting Range	Default Value	Description
ALCControlReference	-	1: Selected Channel	<p>Sets the channel to be used for ALC control reference.</p> <p>Note: Color models only.</p> <p>0: Peak Channel 1: Selected Channel</p>
ALCControlChannel	0: Red 1: Green 2: Blue	1: Green	<p>When ALCControlReference is set to SelectedChannel, this setting determines which RGB channel signal is used for ALC control.</p> <p>When ALCControlReference is set to PeakChannel, this setting is disabled.</p> <p>Note: Color models only.</p>
ALCReference	5 ~ 95	50	Set the target level for ALC. (unit: %)
ALCAreaSelector	-	0: Low Right	<p>Select the area for which to configure ALCAreaEnable.</p> <p>0: Low Right 1: Low Mid-Right 2: Low Mid-Left 3: Low Left 4: Mid-Low Right 5: Mid-Low Mid-Right 6: Mid-Low Mid-Left 7: Mid-Low Left 8: Mid-High Right 9: Mid-High Mid-Right 10: Mid-High Mid-Left 11: Mid-High Left 12: High Right 13: High Mid-Right 14: High Mid-Left 15: High Left</p>
ALCAreaEnable	0: False 1: True	1: True	Enable/disable the photometry area selected in ALCAreaSelector.

Auto Level Control Item	Setting Range	Default Value	Description
ALCAreaEnableAll	0: False 1: True	1: True	True: Operate ALC with all areas designated as photometry areas, regardless of the individual enabled/disabled photometry area states configured in ALCAreaSelector. False: Operate ALC according to the individual enabled/disabled photometry area states configured in ALCAreaSelector.
ALCControlRatio	1~ 100	90	Set the response speed (%). (100 is the fastest.)
AutoControlStatus	-	0: Idle	Allows confirmation of the AGC, ASC, and AWB convergence status. 0: Idle 1: Processing - Exposure Time 2: Processing - Gain 3: Converging - Exposure Time 4: Converging - Gain 5: Error1 - could not processing 6: Error2 - timeout
ExposureAutoControlMin	-	100	Set the minimum value for the ExposureTime control range. (us) Min: 100 Max: ExposureTimeMax-1
ExposureAutoControlMax	-	ExposureTimeMax	Set the maximum value for the ExposureTime control range. (us) Min: ExposureAutoControlMin+1 Max: ExposureTimeMax
GainAutoControlMin	-	1	Set the minimum value for the GainAuto control range. (Step ≙ 0.1dB) Min: 1 Max: (GainAutoControlMax - 1)
GainAutoControlMax	-	126	Set the maximum value for the GainAuto control range. (Step ≙ 0.1dB) Min: GainAutoControlMin+1 Max: 126

ColorTransformationControl

Configure color transformation settings.

Related Topic: [Color Space Conversion \(ColorTransformationControl\)](#)

Note: This function is available only when the [Pixel Format](#) is set to **RGB8**, **RGB10V1Packed**, or **RGB10p32**.

Color Transformation Control Item	Setting Range	Default Value	Description
ColorTransformationMode	0: RGB 2: XYZ	0: RGB	Set the output image format.
ColorTransformationRGBMode	0: OFF 1: sRGB 2: AdobeRGB 3: UserCustom	0: OFF	Set the detailed mode when RGB is selected for the color space.
ColorMatrixValueSelector	0: R-R 1: R-G 2: R-B 3: G-R 4: G-G 5: G-B 6: B-R 7: B-G 8: B-B	0: R-R	Select the ColorMatrix setting component.
ColorMatrixValue	-2 ~ 2	-	Set the Color Matrix value. (Step = 0.1) Default: ColorMatrixValueSelector=0,4,8: 1.0 ColorMatrixValueSelector=1,2,3,5,6,7: 0

ImagingControl

Configure other JAI functions.

Imaging Control Item	Setting Range	Default Value	Description
VideoProcessBypassMode	0: Off 1: On	0: Off	Enable/disable VideoProcessBypass mode.
Related Topic: VideoProcessBypassMode			
EdgeEnhancerEnable	0: Off 1: On	0: Off	Enable/disable EdgeEnhancer. Note: Monochrome models only.
Related Topic: Edge Enhancer , Color Enhancer			
EdgeEnhancerLevel	0: Low 1: Middle 2: High 3: Strong	1: Middle	Set the Level for EdgeEnhancer. Note: Monochrome models only.
ColorEnhancerEnable	0: Off 1: On	0: Off	Enable/disable ColorEnhancer. Note: This function is available only when the Pixel Format is set to RGB8 , RGB10V1Packed , or RGB10p32 .
Related Topic: Edge Enhancer , Color Enhancer			
ColorEnhancerSelector	0: Red 1: Cyan 2: Green 3: Magenta 4: Blue 5: Yellow	0:Red	Index for configuring detailed settings of ColorEnhancer.
ColorEnhancerValue	0~ 1.0	0	Set the enhancement to one of ten levels for each color element. (Step = 0.1) 0: No enhancement

ShadingControl

Configure shading correction settings.

Related Topic: [Shading Correction](#)

Shading Control Item	Setting Range	Default Value	Description
ShadingCorrectionMode	-	0: Flat Shading	Select the shading correction method. 0: Flat Shading 1: Color Shading (Color models only)
ShadingMode	0: Off 1: User1 2: User2 3: User3	0: Off	Set the area to which to save shading correction data. When this is set to Off, PerformShadingCalibration will not be executed.
PerformShadingCalibration	-	-	Execute shading correction. This command can not be executed under the following conditions. - When outputting no image. - When outputting TestPattern. - Width and/or Height are less than 512 (ROI Function (Single ROI)) - In FD2x2Binning mode (Binning Function) - In ImageScaling mode (Image Scaling Mode (Xscale)) - In Decimation mode (Decimation Mode) - In Sequencer mode (Sequencer Function) - In MultiRoi mode (ROI Function (Multi ROI)) - In Reverse mode (Image Flip Function) - In GradationCompression mode (Gradation Compression Mode) - In ALC mode (ALC (Automatic Level Control) Function) - AcquisitionMode is set to other than Continuous (AcquisitionControl)
ShadingDetectResult	-	0: Idle	Display the shading correction results. 0: Idle 1: Succeeded 2: Error1 - image was too bright 3: Error2 - image was too dark 4: Error3 - could not calibrated 5: Error4 - correction limit 6: Error5 - timeout

BlemishControl

Configure settings for JAI white blemish correction.

Related Topic: [BlemishCompensation](#)

Blemish Control Item	Setting Range	Default Value	Description
BlemishEnable	-	1: Enable	Enable/disable blemish correction. 0: Disable all 1: Enable 2: Disable user detection
BlemishDetect	-	-	Execute blemish detection. This command cannot be executed under the following conditions. - No image is being output. - TestPattern is being output - In Sequencer Mode (Sequencer Function) - In MultiRoi mode (ROI Function (Multi ROI)) - The image is not full ROI size (ROI Function (Single ROI)) - In Reverse mode (Image Flip Function) - GradationCompressionMode is not Off (Gradation Compression Mode) - AcquisitionMode is not Continuous (Acquisition Control) - Not in lens cap state
BlemishDetectionResult	-	0	Display the blemish detection results. 0: Idle 1: Succeeded 2: Error1 - image was too bright 3: Error2 - image was too dark (unused) 4: Error3 - signal level was unbalanced (unused) 5: Error4 - detect blemishes too many 6: Error5 - could not detected 7: Error6 - timeout
BlemishDetectThreshold	1~99	10	Set the blemish detection threshold.
BlemishStore	-	-	Save the location information of detected blemishes, manually specified by BlemishiCompensationPositionX and BlemishCompensationPositionY.
BlemishCompensationIndex	1~2000	1	Select the index for the target blemish coordinates.
BlemishCompensationPositionX	-	-1	Display the X coordinate (horizontal pixel position) of the target blemish selected in BlemishCompensationIndex. You can also manually enter the X coordinate of the blemish you want to correct. Min: -1 Max: WidthMax - 1

Blemish Control Item	Setting Range	Default Value	Description
BlemishCompensation PositionY	-	-1	Display the Y coordinate (vertical pixel position) of the target blemish selected in BlemishCompensationIndex. You can also manually enter the Y coordinate of the blemish you want to correct. Min: -1 Max: HeightMax - 1
BlemishCompensation DataClear	-	-	Delete detected or specified blemish information selected in BlemishCompensationIndex.
BlemishCompensationNumber	0~2000	0	Display the number of target blemishes.

SequencerControl

Configure sequencer settings.

Related Topic: [Sequencer Function](#)

Note: Refer to [Functions That Cannot Be Used Together](#) for usage restrictions.

Sequencer Control Item	Setting Range	Default Value	Description
SequencerMode	0: Off 1: On	0: Off	Enable/disable SequencerMode.
SequencerModeSelect	-	0	Select the sequencer mode. 0: TriggerSequencerMode (Default) 1: CommandSequencerMode
SequencerSetSelector	1 ~ 32	1	Select the index number to configure.
SequencerWidth	-	WidthMax value	Set the width of the selected SequencerIndex. Setting Range: 96 (48)* ~ [WidthMax - OffsetX], Step 8(4)* *For monochrome models, when BinningHorizontal = 2, the value in parentheses is applicable.
SequencerHeight	-	HeightMax value	Set the height of the selected SequencerIndex. Setting Range: 8 (4)* ~ [HeightMax - OffsetY], Step 2(1)* *For monochrome models, when BinningVertical = 2 or FD2x2BinningMode = On, the value in parentheses is applicable.
SequencerOffsetX	-	0	Set the horizontal offset value for the selected SequencerIndex. Setting Range: 0 ~ [WidthMax - Width], Step 8(4)* *For monochrome models, when BinningHorizontal = 2, the value in parentheses is applicable.

Sequencer Control Item	Setting Range	Default Value	Description
SequencerOffsetY	-	0	Set the vertical offset value for the selected SequencerIndex. Setting Range: 0~ [Height - Height], Step 2(1)* *For monochrome models, when BinningVertical = 2, the value in parentheses is applicable.
SequencerFrameCount	1~ 65535	1	Set the FrameCount value for the selected SequencerIndex. Note: The same value with AcquisitionFrameCount (AcquisitionControl)
SequencerExposureTime	1~ 8000000	-	Set the exposure time for the selected SequencerIndex. Default: ExposureTimeMax (AcquisitionControl)
SequencerGainAnalogAll	1.0~ 126.0	1	Set the Gain[AnalogAll] value for the selected SequencerIndex. Note: The same value with Gain[AnalogAll] (AnalogControl)
SequencerGainDigitalRed	0.447~ 5.624	1	Set the Gain[DigitalRed] value for the selected SequencerIndex. Note: The same value with Gain[DigitalRed] (AnalogControl). Color models only.
SequencerGainDigitalBlue	0.447~ 5.624	1	Set the Gain[DigitalBlue] value for the selected SequencerIndex. Note: The same value with Gain[DigitalBlue] (AnalogControl). Color models only.
SequencerLUTEnable	0: False 1: True	0: False	Set the LutEnable value for the selected SequencerIndex.
SequencerSetNext	0~ 32	-	Set the next index to be displayed for the selected SequencerIndex. (Enabled only for TriggerSequencer.) If 0 is specified, the operation of the Sequencer is stopped. SequencerSetSelector = 1~ 31: (SequencerSetSelector+1) SequencerSetSelector = 32: 1
SequencerRepetition	1~ 255	1	Set the repeat count for the sequencer.
SequencerSetActive	1~ 32	1	Displays the active index number.
SequencerSetStart	1~ 32	1	Specify the first index number to switch to when starting TriggerSequencerMode.
SequencerCommandIndex	1~ 32	1	Set this to change the SequencerIndex. (Enabled only for CommandSequencer.)
SequencerReset	-	-	In TriggerSequencerMode, reset the current index number to the number configured in SequencerSetStart.

CounterAndTimerControl

Configure counter settings.

Note: This camera only supports the counter functions.

Related Topic: [Counter and Timer Control Function](#)

Counter and Timer Control Item	Setting Range	Default Value	Description
CounterSelector	0: Counter0 1: Counter1 2: Counter2 3: Counter3	0: Counter0	Select the counter.
CounterEventSource	-	0: Off	Assign the Counter Event signal for which you want to read the count value to a dedicated counter, and read the value. 0: Off 1: FrameTrigger (Counter0 only) 2: Exposure Start (Counter1 only) 3: Sensor Readout (Counter2 only) 4: FrameTransferEnd (Counter3 only)
CounterEventActivation	1:Rising Edge 2:Falling Edge	-	Set the count timing. The setting value is fixed with the following data. Default: CounterSelector=0, 1, 2: Rising Edge CounterSelector=3: Falling Edge
CounterReset	-	-	Reset the counter.
CounterValue	0~ 32bit max	0	Display the count value.
CounterStatus	-	0: CounterIdle	Display the counter status. 0: CounterIdle 1: CounterTriggerWait 2: CounterActive 3: CounterCompleted 4: CounterOverflow - Count value exceeded the maximum value

ActionControl

Configures action control settings.

Related Topic: [Action Control Function](#)

Action Control Item	Setting Range	Default Value	Description
ActionDeviceKey	0x00000000 ~ 0xFFFFFFFF	0x00000000	An action command is executed if this ActionDeviceKey matches the DeviceKey contained in the action command message.
ActionQueueSize			Displays the queue size of ScheduledActionCommand. This value represents the maximum number of ScheduledActionCommands that can be pending at the time a ScheduledActionCommand is given in time.
ActionSelector	0:Off 1:On	0:Off	Select the ActionSelector.
ActionGroupMask	0x00000000 ~ 0xFFFFFFFF	0x00000000	An action command is executed if the result of an AND operation of GroupMask contained in this ActionGroupMask and an action command message is not 0.
ActionGroupKey	0x00000000 ~ 0xFFFFFFFF	0x00000000	An action command is executed if this ActionGroupKey matches the GroupKey contained in the action command message.

EventControl

Configure settings for event control.

Related Topic: [Event Control Function](#)

Event Control Item	Setting Range	Default Value	Description
EventSelector	-	0: Acquisition Trigger	Select the event to send the event message. 0: AcquisitionTrigger 1: FrameStart 2: FrameEnd 5: ExposureStart 6: ExposureEnd
EventNotification	0: Off 1: On	0: Off	Sets whether or not to send an event message when an event selected by EventSelector occurs.
EventAcquisitionTriggerData	-	-	When the event AcquisitionTrigger occurs, the following three data can be checked.
EventAcquisitionTrigger	-	0x9002	Displays the EventID (0x9002).
EventAcquisitionTriggerTimestamp	0~ 64bit max	0	Displays the Timestamp value when an event occurs.
EventAcquisitionTriggerFrameID	-	0 (Fixed)	Displays the FrameID value when an event occurs.
EventFrameStartData	-	-	When the event FrameStartData occurs, the following three data can be checked.
EventFrameStart	-	0x9300	Displays the EventID (0x9300).
EventFrameStartTimestamp	0~ 64bit max	0	Displays the Timestamp value when an event occurs.
EventFrameStartFrameID	-	0 (Fixed)	Displays the FrameID value when an event occurs.
EventFrameEndData	-	-	When the event FrameEndData occurs, the following three data can be checked.
EventFrameEnd	-	0x9301	Displays the EventID (0x9301).
EventFrameEndTimestamp	0~ 64bit max	0	Displays the Timestamp value when an event occurs.
EventFrameEndFrameID	-	0 (Fixed)	Displays the FrameID value when an event occurs.
EventExposureStartData	-	-	When the event ExposureStartData occurs, the following three data can be checked.
EventExposureStart	-	0x9003	Displays the EventID (0x9003).
EventExposureStartTimestamp	0~ 64bit max	0	Displays the Timestamp value when an event occurs.
EventExposureStartFrameID	-	0 (Fixed)	Displays the FrameID value when an event occurs.
EventExposureEndData	-	-	When the event ExposureEndData occurs, the following three data can be checked.
EventExposureEnd	-	0x9004	Displays the EventID (0x9004).
EventExposureEndTimestamp	0~ 64bit max	0	Displays the Timestamp value when an event occurs.
EventExposureEndFrameID	-	0 (Fixed)	Displays the FrameID value when an event occurs.

ChunkDataControl

Configure Chunk Control settings.

Related Topic: [Chunk Data Function](#)

Chunk Data Control Item	Setting Range	Default Value	Description
ChunkModeActive	0: Off 1: On	0: Off	Set whether to enable ChunkData.
ChunkOffsetX	-	-	Display the OffsetX value (ImageFormatControl) ChunkID: 0x00002000
ChunkOffsetY	-	-	Display the OffsetY value (ImageFormatControl) ChunkID: 0x00002001
ChunkWidth	-	-	Display the Width value (ImageFormatControl) ChunkID: 0x00002002
ChunkHeight	-	-	Display the Height value (ImageFormatControl) ChunkID: 0x00002003
ChunkLineStatusAll	-	-	Display the LineStatusAll value (DigitalIOControl) ChunkID: 0x00002013
ChunkExposureTime	-	-	Display the ExposureTime value (us). ChunkID: 0x00002004 Note: The value displayed in ChunkExposureTime includes the exposure offset value (2us). ChunkExposureTime: <i>ExposureTime</i> (AcquisitionControl) value + 2us
ChunkGainSelector	0: Analog All 1: Digital Red 2: Digital Blue	0: Analog All	Select the Gain to configure.
ChunkGain	-	-	Display the Gain value (AnalogControl) 0: Analog All - ChunkID: 0x0000201F 1: Digital Red - ChunkID: 0x00002006 3: Digital Blue - ChunkID: 0x00002007
ChunkFrameTriggerCounter	-	-	Display the value for CounterValue[Counter0] (CounterAndTimerControl). Data acquisition timing is FrameStart. ChunkID: 0x0000200E
ChunkSequencerSetActive	-	-	Displays the SequencerSet number currently set in TriggerSequenceMode or CommandSequencerMode. (1 is displayed in Normal Mode.) (SequencerControl) ChunkID: 0x0000200C

TestControl

Configure the test control setting.

Test Control Item	Setting Range	Default Value	Description
TestPendingAck	0~ 10000	0	PendingAck function test command. The camera waits for TestPendingAck (ms) time and returns an Ack response.

UserSetControl

Configure user settings.

Related Topic: [Step 7: Save the Settings](#)

User Set Control Item	Setting Range	Default Value	Description
UserSetSelector	-	0: Default	Select the user settings. 0: Default - Invalid when executing UserSetSave 1: User1 2: User2 3: User3
UserSetLoad	-	-	Read the user settings specified in UserSetSelector. When selecting Default for UserSetSelector, the factory settings are loaded.
UserSetSave	-	-	Overwrite the current setting values with the user settings specified in UserSetSelector. Invalid when UserSetSelector is set to Default.

Miscellaneous

Troubleshooting

Check the following before requesting help. If the problem persists, contact your local JAI distributor.

Power Supply and Connections

Issue: The POWER/TRIG LED remains lit amber and does not turn green, even after power is supplied to the camera.

Cause and Solution:

- Camera initialization may not be complete due to a lack of power. Check the 6-pin power cable connection.

Or the GigE connection may be not established. Check the ethernet cable connection.

Image Display

Issue: Gradation in dark areas is not noticeable.

Cause and Solution: Use the gamma function to correct the display. As the light-emitting properties of the monitor are not linear, the entire image may be darker or the gradation in the dark areas may be less noticeable when camera outputs are displayed without processing. Using the gamma function performs correction to produce a display that is close to linear. For details, see [Gamma Function](#).

Settings and Operations

Issue: Settings cannot be saved to user memory.

Cause and Solution: You cannot save to user memory while images are being acquired by the camera. Stop image acquisition before performing the save operation.

Issue: I want to restore the factory default settings.

Cause and Solution: Load Default under User Set Selector in the Feature Properties tab to restore the factory default settings.

Specifications

Item	Monochrome	Color	
Scanning System	Progressive scan, 1 tap		
Synchronization	Internal		
Interface	5GBASE-T Ethernet (GigE Vision 2.0), IEEE 802.3af		
Image Sensor	Monochrome CMOS	Bayer Color CMOS	
Dark SN	>60 dB@10bit		
	Conditions:		
	GOX-5105MC-5GE	AnalogGainAll:x1.0,Shutter:OFF, SensorDigitizationBits=12bit, Mono10/Bayer10, Frame Rate: TBD fps	
	GOX-8105MC-5GE	AnalogGainAll:x1.0,Shutter:OFF, SensorDigitizationBits=12bit, Mono10/Bayer10, Frame Rate: TBD fps	
	GOX-12405MC-5GE	AnalogGainAll:x1.0,Shutter:OFF, SensorDigitizationBits=12bit, Mono10/Bayer10, Frame Rate: TBD fps	
	GOX-16205MC-5GE	AnalogGainAll:x1.0,Shutter:OFF, SensorDigitizationBits=12bit, Mono10/Bayer10, Frame Rate: TBD fps	
	GOX-20405MC-5GE	AnalogGainAll:x1.0,Shutter:OFF, SensorDigitizationBits=12bit, Mono10/Bayer10, Frame Rate: TBD fps	
	GOX-24505MC-5GE	AnalogGainAll:x1.0,Shutter:OFF, SensorDigitizationBits=12bit, Mono10/Bayer10, Frame Rate: TBD fps	
Bright SN	>38 dB	>36 dB(Gch)	
Image Size (Effective Image)	GOX-5105MC-5GE	Type 1/1.8	6.8 mm x 5.7 mm (8.82mm diagonal)
	GOX-8105MC-5GE	Type 2/3	7.8 mm x 7.8 mm (11.05mm diagonal)
	GOX-12405MC-5GE	Type 1/1.1	11.3 mm x 8.2 mm (14.00mm diagonal)
	GOX-16205MC-5GE	Type 1.1	14.6 mm x 8.3 mm (16.81mm diagonal)
	GOX-20405MC-5GE	Type 1.1	12.4 mm x 12.4 mm (17.48mm diagonal)
	GOX-24505MC-5GE	Type 1.2	14.6 mm x 12.6 mm (19.30mm diagonal)
Pixel Size	2.74 μm x 2.74 μm		
Effective Image Pixel	GOX-5105MC-5GE: 2472 x 2064 GOX-8105MC-5GE: 2856 x 2848 GOX-12405MC-5GE: 4128 x 3008 GOX-16205MC-5GE: 5328 x 3040 GOX-20405MC-5GE: 4512 x 4512 GOX-24505MC-5GE: 5328 x 4608		

Item	Monochrome	Color	
Acquisition Frame Rate (Max) Mono8, BayerRG8, Bayer GR8, BayerGB8, BayerBG8, RGB8		PacketSize 1476	PacketSize 12036
	GOX-5105MC-5GE	98 fps	103 fps
	GOX-8105MC-5GE	62 fps	66 fps
	GOX-12405MC-5GE	41 fps	43 fps
	GOX-16205MC-5GE	32 fps	33 fps
	GOX-20405MC-5GE	25 fps	27 fps
	GOX-24505MC-5GE	21 fps	22 fps
Note: SensorDigitizationBits is set to 10Bits, NetworkThroughputSafetyMargin is set to 92, ExtendedIDMode = Off.			
Acquisition Frame Rate (Max) Mono10Packed, Mono12Packed, BayerRG10Packed, BayerRG12Packed, BayerGR10Packed, BayerGR12Packed, BayerGB10Packed, BayerGB12Packed, BayerBG10Packed, BayerBG12Packed, RGB10V1Packed		PacketSize 1476	PacketSize 12036
	GOX-5105MC-5GE	65 fps	69 fps
	GOX-8105MC-5GE	41 fps	44 fps
	GOX-12405MC-5GE	27 fps	29 fps
	GOX-16205MC-5GE	21 fps	22 pfs
	GOX-20405MC-5GE	17 fps	18 fps
	GOX-24505MC-5GE	14 fps	15 fps
Notes: <ul style="list-style-type: none"> • SensorDigitizationBits is set to 10Bits, NetworkThroughputSafetyMargin is set to 92, ExtendedIDMode = Off. • If SensorDigitizationBits is set to smaller than the pixel format bits configured in the Pixel Format, the image may have gaps in the histogram. 			
Acquisition Frame Rate (Max) Mono10, Mono12, BayerRG10, BayerRG12, BayerGR10, BayerGR12, BayerGB10, BayerGB12, BayerBG10, BayerBG12, RGB10p32		PacketSize 1476	PacketSize 12036
	GOX-5105MC-5GE	49 fps	51 fps
	GOX-8105MC-5GE	31 fps	33 fps
	GOX-12405MC-5GE	20 fps	21 fps
	GOX-16205MC-5GE	16 fps	16 pfs
	GOX-20405MC-5GE	12 fps	13 fps
	GOX-24505MC-5GE	10 fps	11 fps
Notes: <ul style="list-style-type: none"> • SensorDigitizationBits is set to 10Bits, NetworkThroughputSafetyMargin is set to 92, ExtendedIDMode = Off. • If SensorDigitizationBits is set to smaller than the pixel format bits configured in the Pixel Format, the image may have gaps in the histogram. 			
Digital Image Output Format - Full	GOX-5105MC-5GE: 2472 x 2064 GOX-8105MC-5GE: 2856 x 2848 GOX-12405MC-5GE: 4128 x 3008 GOX-16205MC-5GE: 5328 x 3040 GOX-20405MC-5GE: 4512 x 4512 GOX-24505MC-5GE: 5328 x 4608		

Item	Monochrome	Color
Digital Image Output Format - ROI (Width)	<p>GOX-5105MC-5GE: 96(48) to 2472 (1236), step 8(4) GOX-8105MC-5GE: 96(48) to 2856(1428), step 8(4) GOX-12405MC-5GE: 96(48) to 4128 (2064), step 8(4) GOX-16205MC-5GE: 96(48) to 5328 (2664), step 8(4) GOX-20405MC-5GE: 96(48) to 4512 (2256), step 8(4) GOX-24505MC-5GE: 96(48) to 5328 (2664), step 8(4)</p> <p>Note: For monochrome models, when BinningHorizontal = 2 or FD2x2BinningMode = On, the value in parenthesis is applicable.</p>	
Digital Image Output Format - ROI (Offset X)	<p>GOX-5105MC-5GE: 0 to [2472 (1236) - Width], step 8(4) GOX-8105MC-5GE: 0 to [2856(1428) - Width], step 8(4) GOX-12405MC-5GE: 0 to [4128 (2064) - Width], step 8(4) GOX-16205MC-5GE: 0 to [5328 (2664) - Width], step 8(4) GOX-20405MC-5GE: 0 to [4512 (2256) - Width], step 8(4) GOX-24505MC-5GE: 0 to [5328 (2664) - Width], step 8(4)</p> <p>Note: For monochrome models, when BinningHorizontal = 2 or FD2x2BinningMode = On, the value in parenthesis is applicable.</p>	
Digital Image Output Format - ROI (Height)	<p>GOX-5105MC-5GE: 8(4) to 2064 (1032), step2(1) GOX-8105MC-5GE: 8(4) to 2848 (1424), step2(1) GOX-12405MC-5GE: 8(4) to 3008 (1504), step2(1) GOX-16205MC-5GE: 8(4) to 3040 (1520), step2(1) GOX-20405MC-5GE: 8(4) to 4512 (2256), step2(1) GOX-24505MC-5GE: 8(4) to 4608 (2304), step2(1)</p> <p>Note: For monochrome models, when BinningVertical = 2 or FD2x2BinningMode = On, the value in parenthesis is applicable.</p>	
Digital Image Output Format - ROI (Offset Y)	<p>GOX-5105MC-5GE: 0 to [2064 (1032) - Height], step2(1) GOX-8105MC-5GE: 0 to [2848 (1424) - Height], step2(1) GOX-12405MC-5GE: 0 to [3008 (1504) - Height], step2(1) GOX-16205MC-5GE: 0 to [3040 (1520) - Height], step2(1) GOX-20405MC-5GE: 0 to [4512 (2256) - Height], step2(1) GOX-24505MC-5GE: 0 to [4608 (2304) - Height], step2(1)</p> <p>Note: For monochrome models, when BinningHorizontal = 2 or FD2x2BinningMode = On, the value in parenthesis is applicable.</p>	
Digital Image Output Format: Binning (H) = 1 and FD2x2BinningMode = Off	<p>GOX-5105M-5GE: 2472 GOX-8105M-5GE: 2856 GOX-12405M-5GE: 4128 GOX-16205M-5GE: 5328 GOX-20405M-5GE: 4512 GOX-24505M-5GE: 5328</p>	N/A

Item	Monochrome	Color
Auto Exposure Response Speed (ALCControlRatio)	1 ~ 100%	
Digital I/O	LineSelector (6P): GPIO IN / GPIO OUT	
Black Level Adjustment	Default Level: 8LSB@8bit All (Mono/Color): -133 ~ +255 LSB Red (Color): -64 ~ +64 LSB Blue (Color): -64 ~ +64 LSB Resolution Adjustment: 1LSB@12bit	
Gain Adjustment	Manual Adjustment Range: AnalogAll (Mono/Color): 0db ~ 42dB DigitalRed (Color): -7dB ~ 15dB DigitalBlue (Color): -7dB ~ 15dB Adjustment Auto Gain: Off, Continuous, Once	
White Balance	WhiteBalanceGain: DigitalRed, DigitalBlue :0.447 ~ 5.624, 1STEP = x 0.0001 BalanceWhiteAuto: Off, Continuous, Once, Preset3200K, Preset5000K, Preset6500K, Preset7500K Photometry Area: 16 (4 x 4) Area Adjustment Range: 3000K ~ 9000K	
Blemish Correction	Detection: Detect white blemishes using threshold values (100 steps available) (black blemish correction performed only at the factory) Correction: Interpolation using adjacent pixels. Continuous blemishes can be corrected up to 3 horizontal pixels (up to 3 horizontal pixels of the same Bayer color, for color models). Correctable pixels: 2000 pixels	
ALC	Video level adjusted automatically using AGC and ASC	
Gamma	0.45, 0.5, 0.55, 0.6, 0.65, 0.75, 0.8, 0.9, 1.0 (9 steps available)	
LUT	OFF : $\gamma = 1.0$, ON = 257 points can be set	
Vibration Resistance	10G (20 Hz ~ 200 Hz X-Y-Z direction)	
Impact Resistance	80G	
Power Supply	PoE: +36V ~ +57V DC TBD W typical @ +48 V 6-pin Connector: +10V ~ +25V DC. TBD W typical @ +12 V	
Lens Mount	<ul style="list-style-type: none"> C-Mount Lens mount protrusion length of 9 mm or less is supported. 	
Flange Back	17.526mm, tolerance: 0 mm ~ -0.05 mm	
Optical Filter	IR cut filter (color model only)	
Verified Performance Temperature/Humidity	-5°C ~ + 45°C / 20% ~ 80% (non-condensing) Note: It may change depending on the installation environment. Please refer to the Cautions in the Package Contents section.	
Storage Temperature/Humidity	-25°C ~ + 60°C / 20% ~ 80% (non-condensing)	

Item	Monochrome	Color
Regulations (Tentative)	CE [EN 55032:2015(CISPR32:2015) Class B, EN 55035:2017 (CISPR35:2016)], FCC Part 15 Class B, EU RoHS/WEEE, China RoHS, KC	
Housing	29mm x 29mm x 68mm (WHD, excluding connectors)	
Weight	TBD g	

Package Contents

- Camera (1)
- Sensor protection cap (1)
- Dear customer (sheet) (1)

Optional Accessories (Sold Separately)

- MP-46 Tripod Adapter Plate

Notes:

- Design and specifications are subject to change without notice.
- Approximately 30 minutes of warm-up are required to achieve these specifications.

Cautions:

The performance specifications given for this camera have been verified for the Operating Temperature range shown in the Specifications table. The camera may be able to perform outside of the specified temperature range, but such performance has not been verified and is therefore not guaranteed.

- The camera's internal temperature sensor detects temperatures of TBD °C or less during operation.

If the above temperature conditions are exceeded, take measures to dissipate heat according to your installation environment and conditions.

Spectral Response (GOX-5105M-5GE/GOX-5105C-5GE)

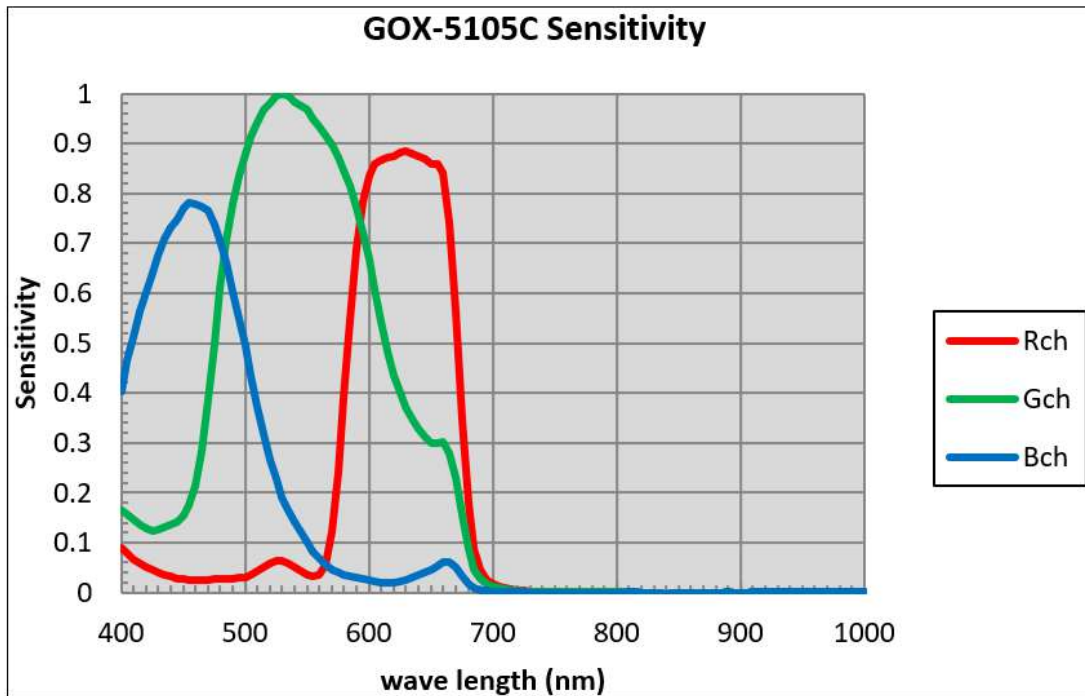
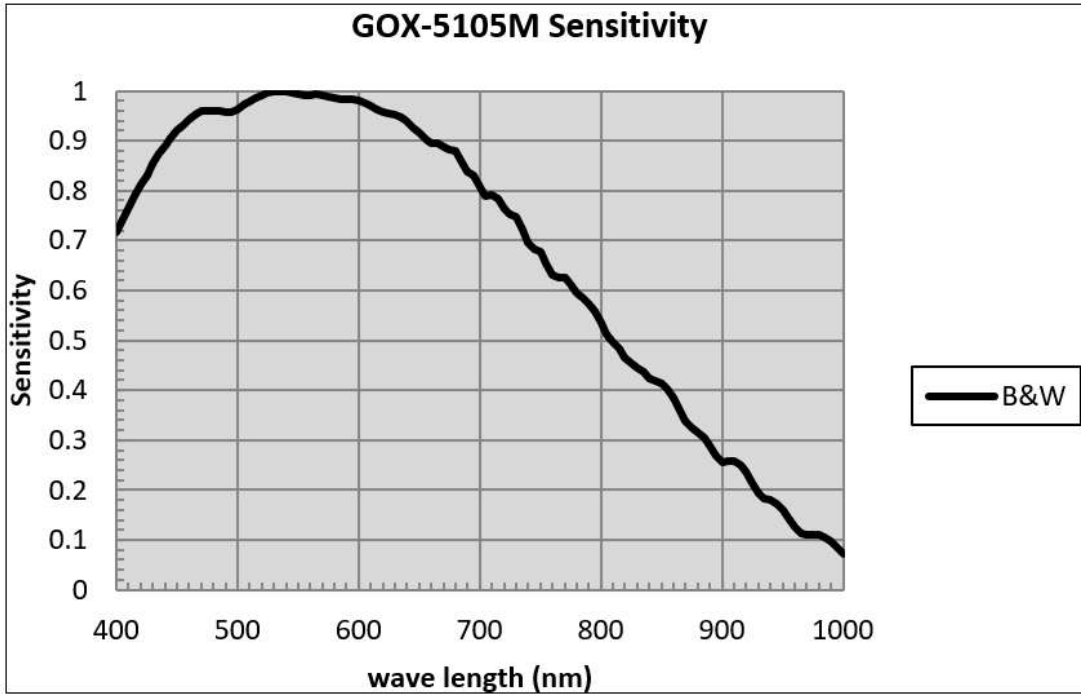

Spectral Response (GOX-8105M-5GE/GOX-8105C-5GE)

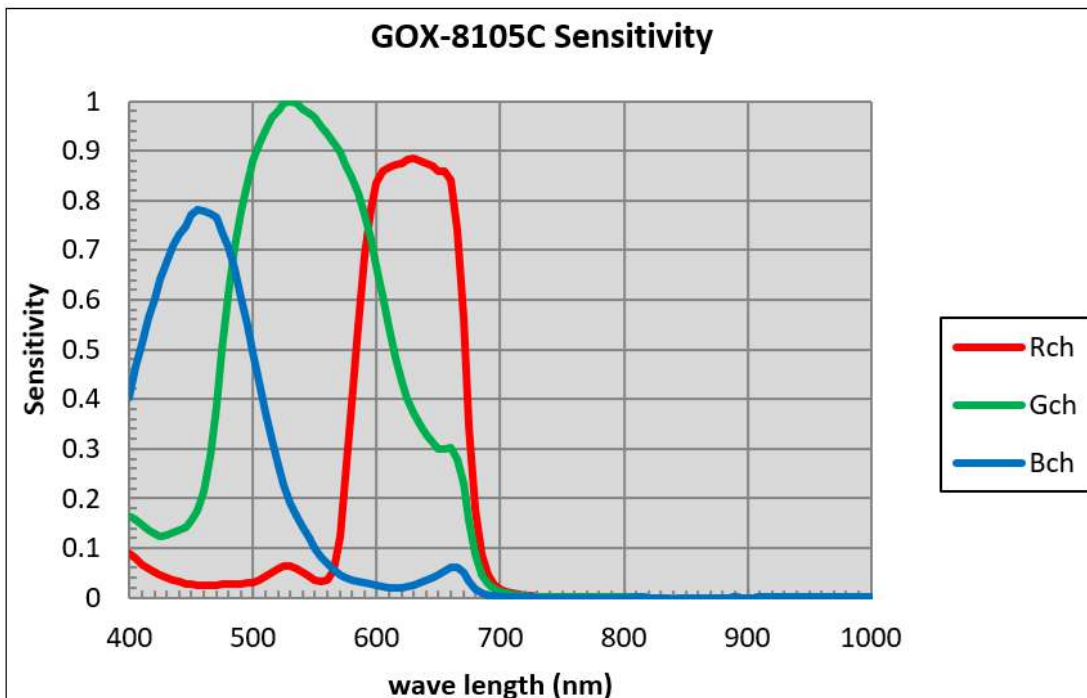
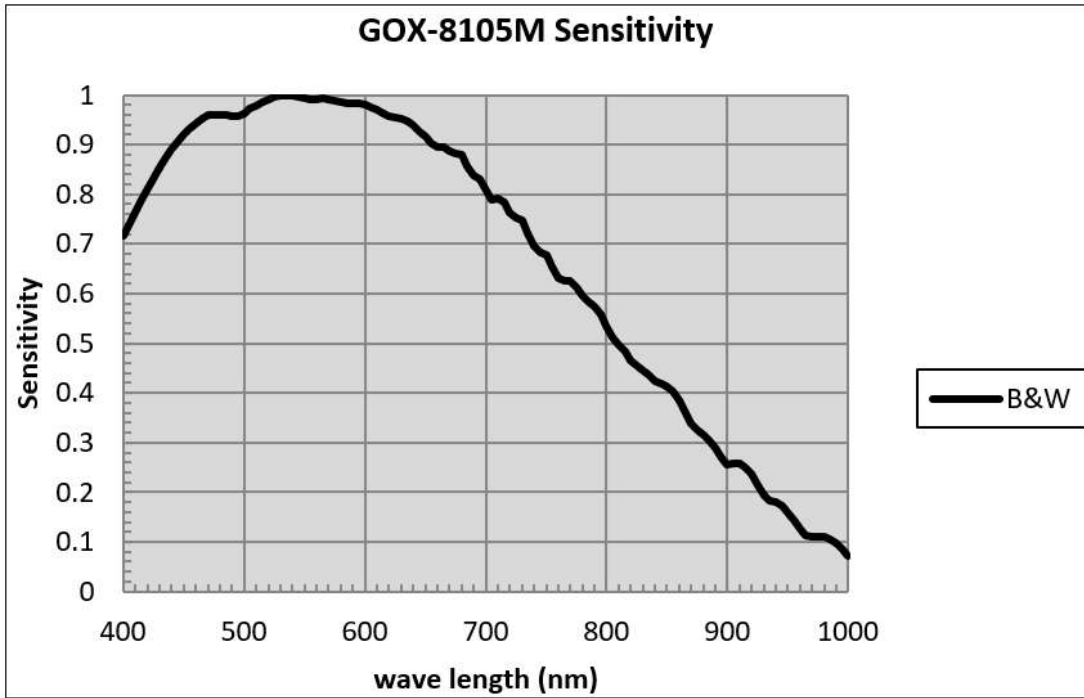

Spectral Response (GOX-12405M-5GE/GOX-12405C-5GE)

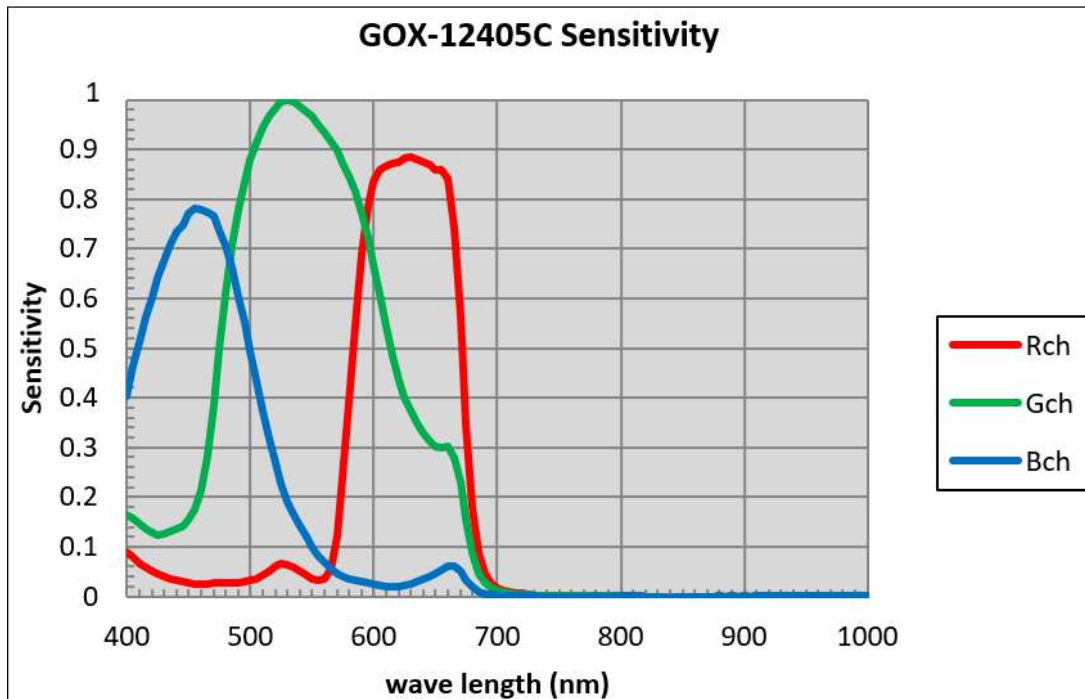
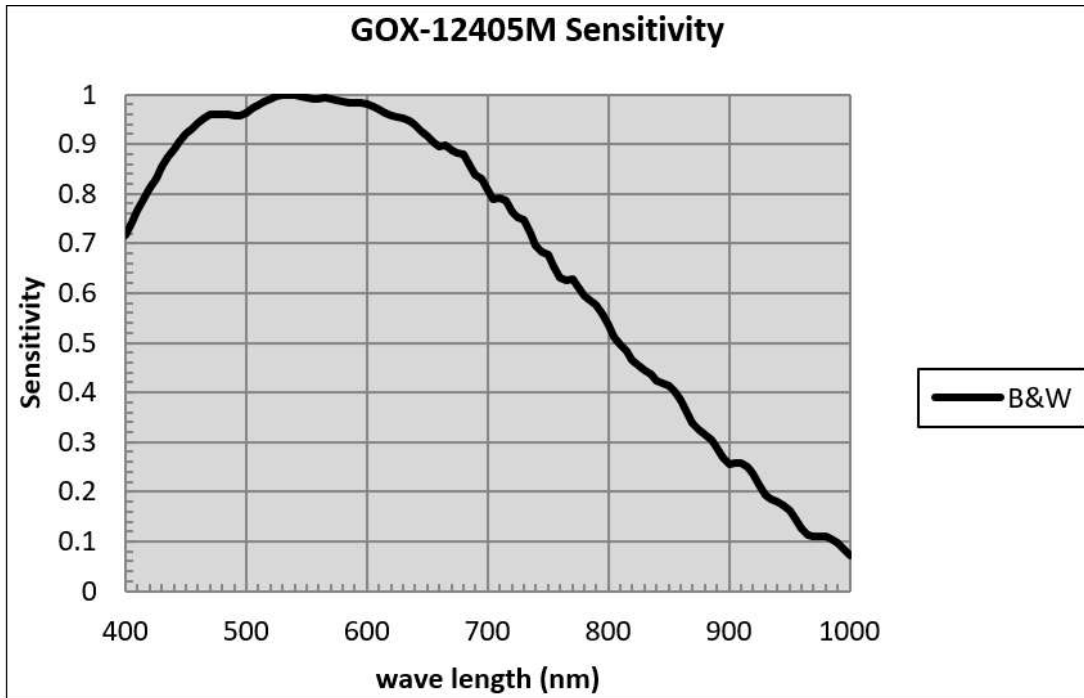

Spectral Response (GOX-16205M-5GE/GOX-16205C-5GE)

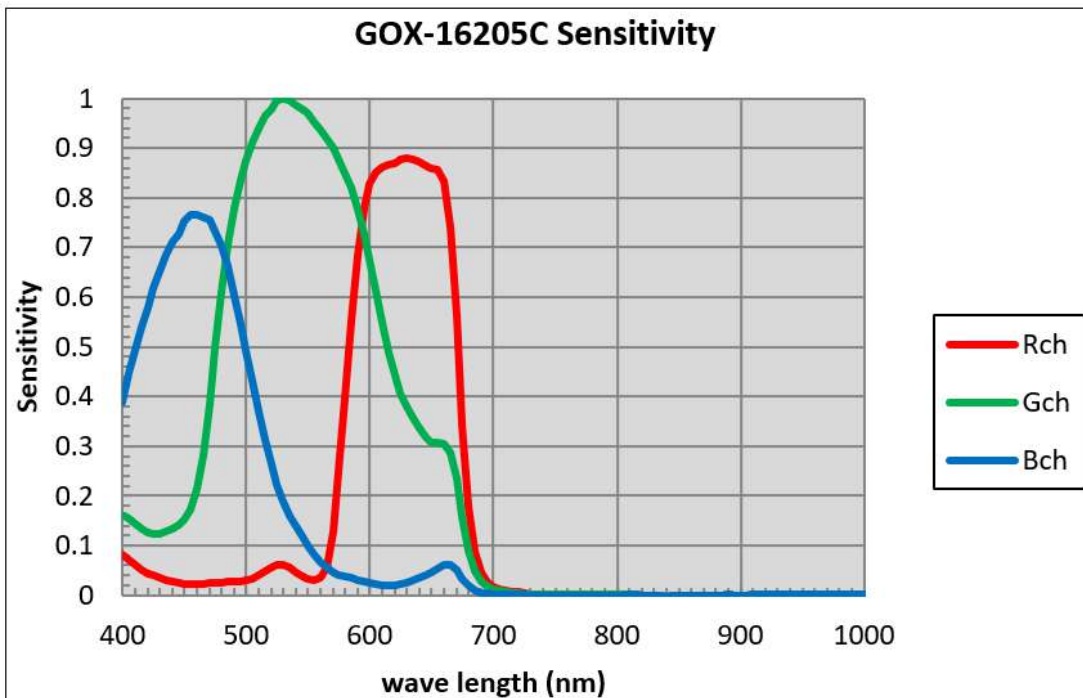
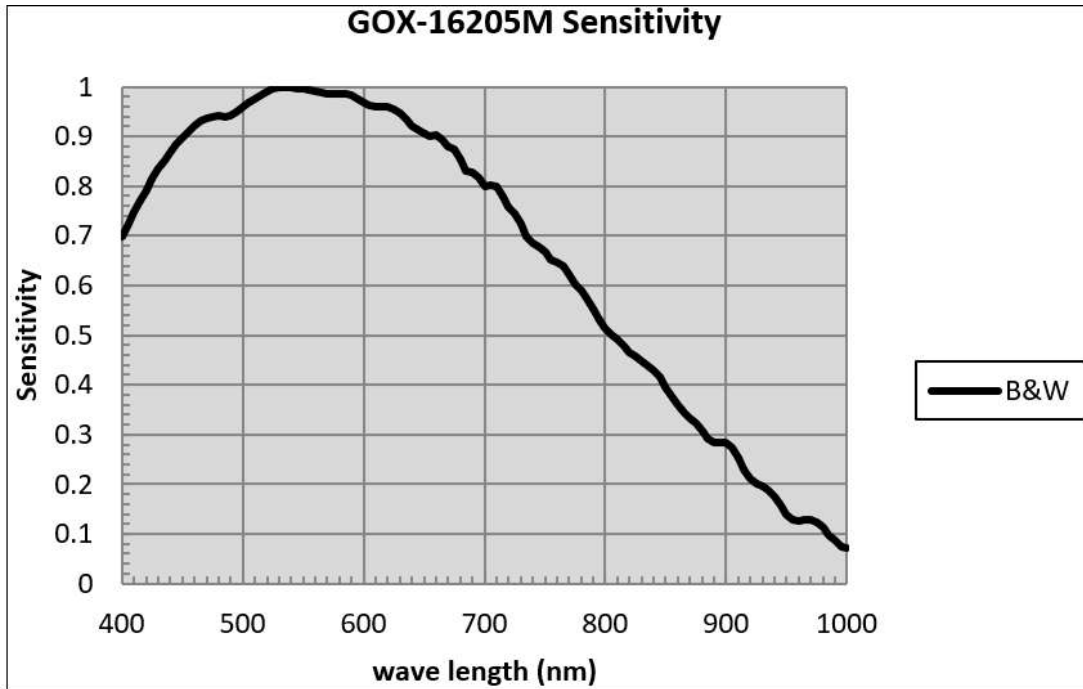

Spectral Response (GOX-20405M-5GE/GOX-20405C-5GE)

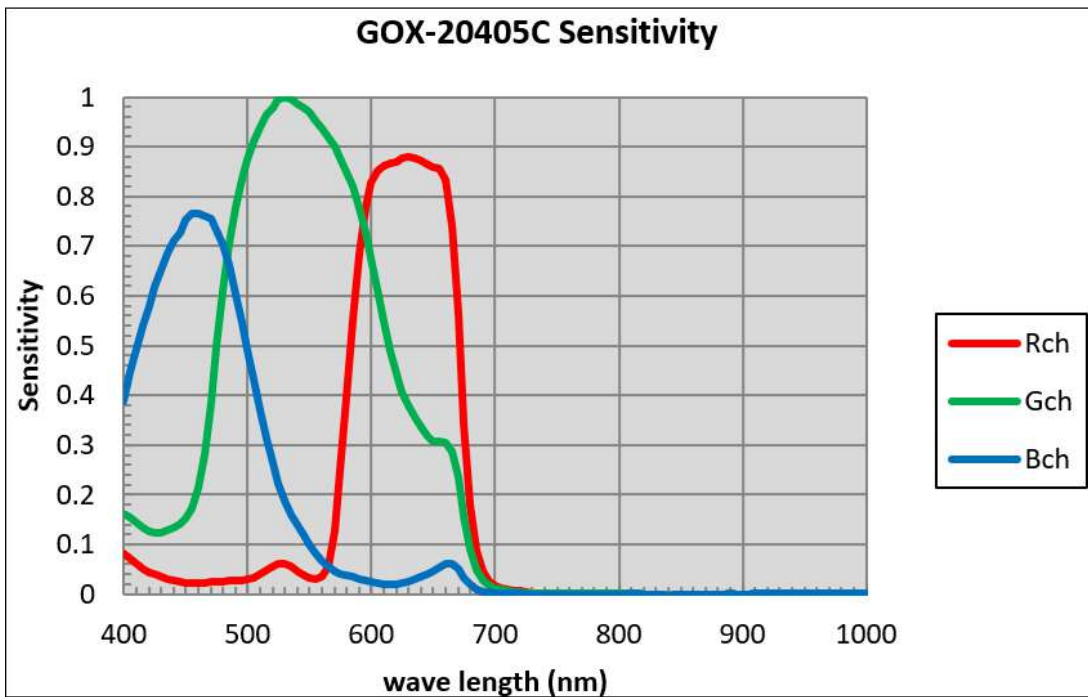
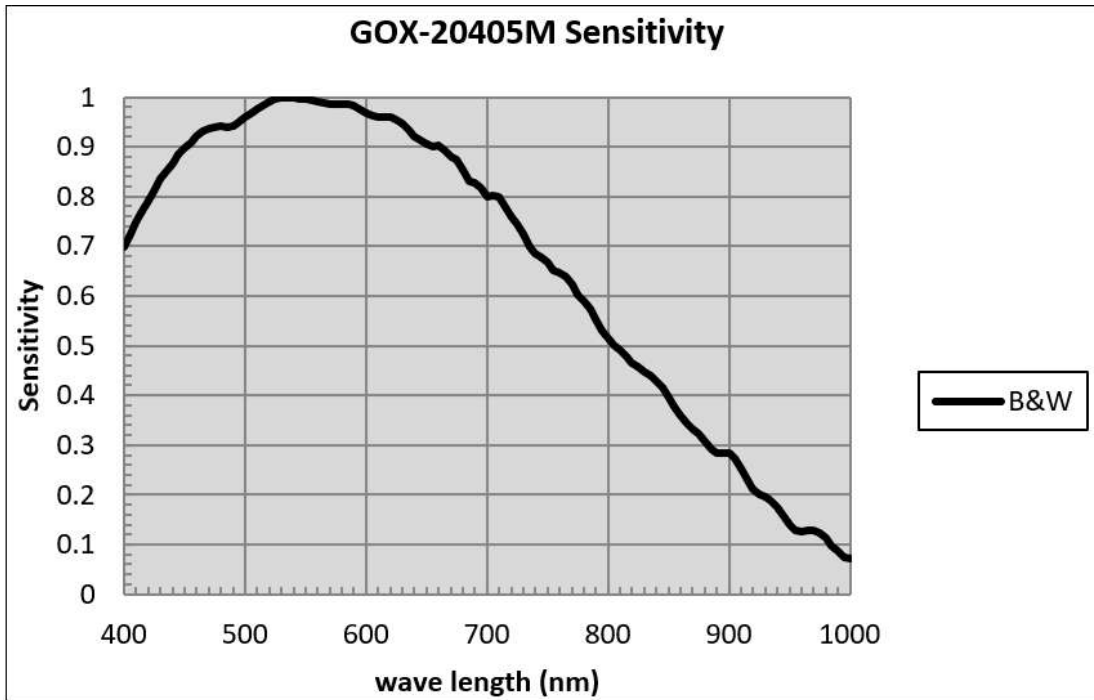

Spectral Response (GOX-24505M-5GE/GOX-24505C-5GE)

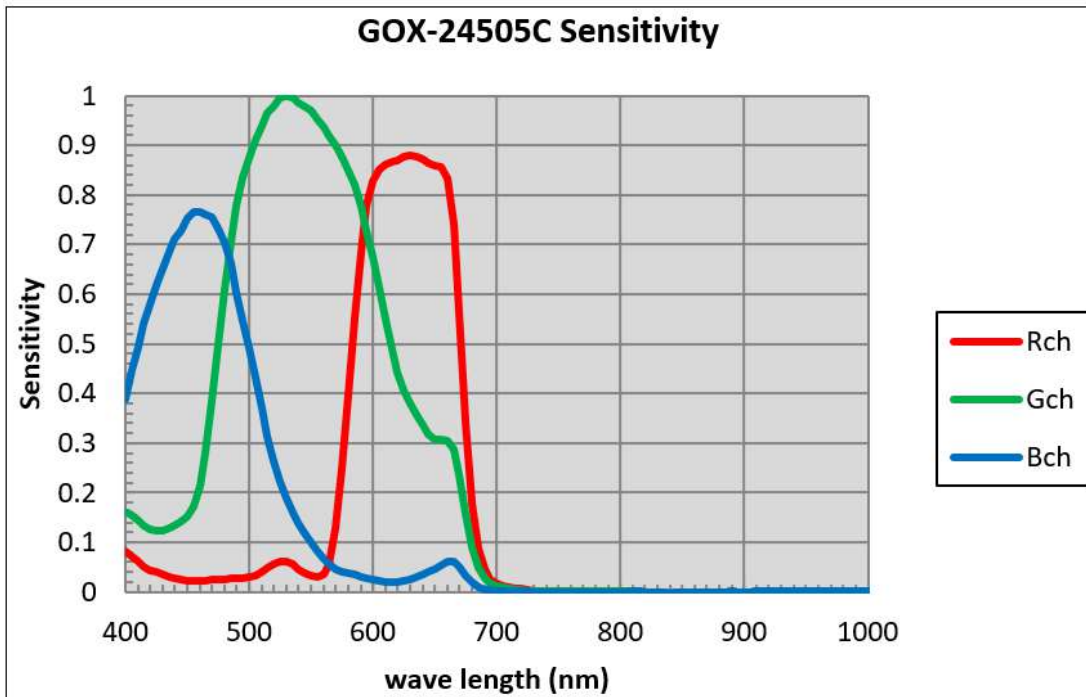
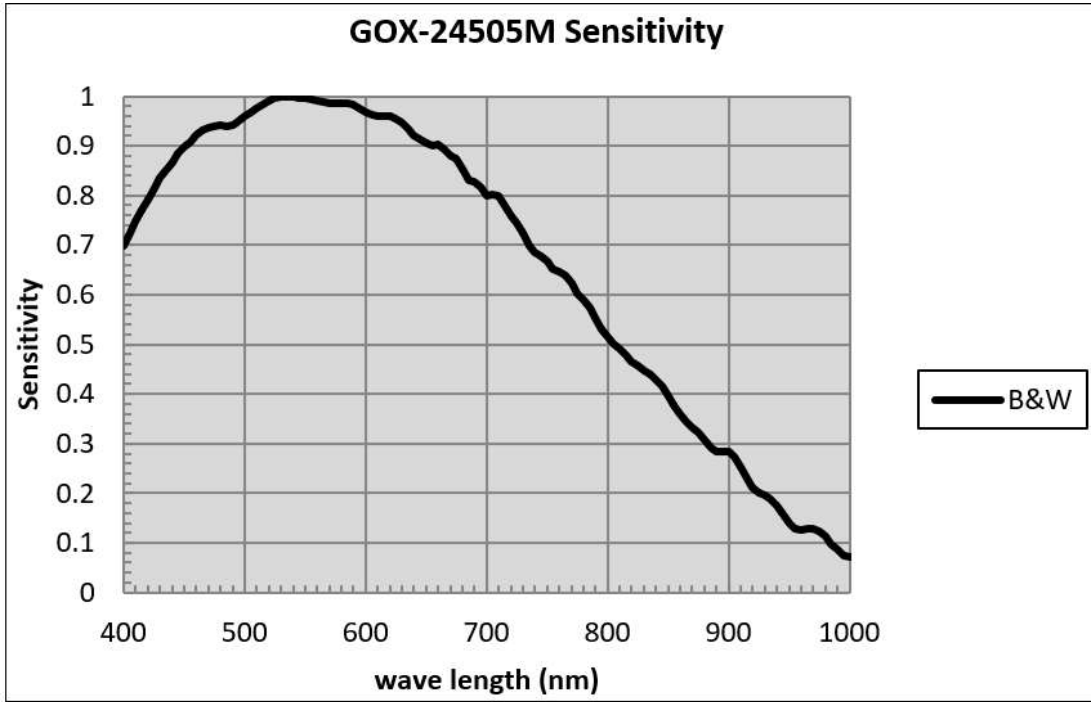

Dimensions

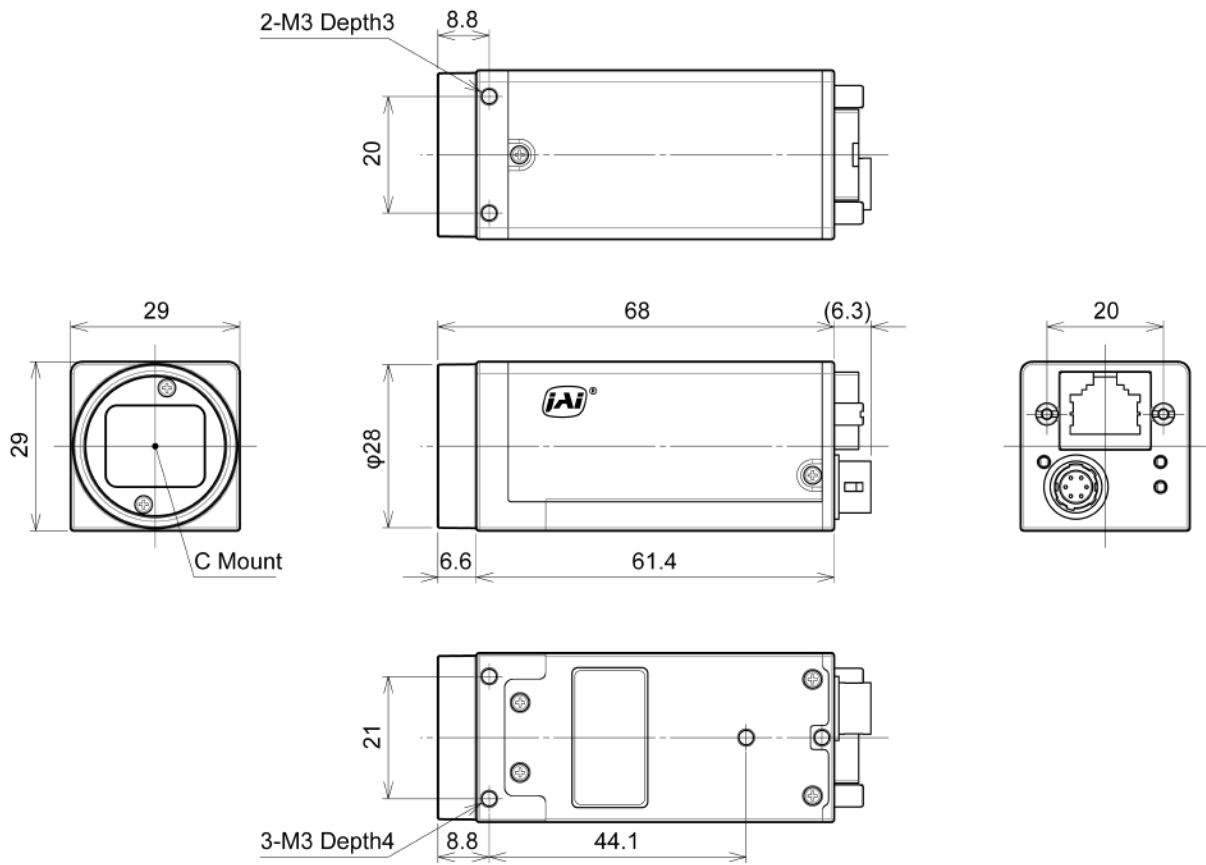

Notes:

- Dimensional tolerance: $\pm 0.3\text{mm}$
- Unit: mm

Comparison of the Decibel Display and Multiplier Display

Decibels [dB]	Multipliers [X]	Remarks
-6	0.501	
-5	0.562	
-4	0.631	
-3	0.708	
-2	0.794	
-1	0.891	
0	1	
1	1.122	
2	1.259	
3	1.413	
4	1.585	
5	1.778	
6	1.995	
7	2.239	
8	2.512	
9	2.818	
10	3.162	
11	3.548	
12	3.981	
13	4.467	
14	5.012	
15	5.623	
16	6.31	
17	7.079	
18	7.943	
19	8.913	
20	10	
21	11.22	
22	12.589	
23	14.125	
24	15.849	
25	17.783	
26	19.953	
27	22.387	
28	25.119	
29	28.184	
30	31.623	
31	35.481	

Decibels [dB]	Multipliers [X]	Remarks
32	39.811	
33	44.668	
34	50.119	
35	56.234	
36	63.096	
37	70.795	
38	79.433	
39	89.125	
40	100	
41	112.202	
42	125.893	

User's Record

Camera type: Go-X Series Global Shutter GigE interface

Model name:

Revision:

Serial No:

Firmware version:

For camera revision history, please contact your local JAI distributor.

Revision History

Revision	Date	Changes
Tentative	2022/09/22	

Trademarks

- Microsoft and Windows are trademarks or registered trademarks of Microsoft Corporation in the United States and other countries.
- Intel and Intel Core are trademarks of Intel Corporation in the United States and other countries.

Other systems and product names described in this document are trademarks or registered trademarks of their respective owners. The ™ and ® symbols are not used in this document.

Europe, Middle East & Africa

Phone +45 4457 8888
Fax +45 4491 8880

Asia Pacific

Phone +81 45 440 0154
Fax +81 45 440 0166

Americas

Phone (Toll-Free) 1 800 445 5444
Phone +1 408 383 0300

Visit our website on www.jai.com



See the possibilities